









JABARA AV BOARD

DESIGN : SHINSAKU MIYAMOTO



reddot design award
best of the best 2019

ABOUT JABARA AV BOARD

THE CLASSICAL ACCORDION-STYLE DOORS INCORPORATED INTO THE JABARA AV BOARD, PROVIDE A SENSE OF TIMELESSNESS TOGETHER WITH DEMONSTRATING THE INDISPENSABLE NATURE OF THIS PIECE OF FURNITURE. THE UNIQUE DOOR IS REMINISCENT OF JAPANESE BEAUTY WHICH CAN BE SEEN IN REED-SCREEN DOORS IN TRADITIONAL TOWNHOUSES DURING THE SUMMERTIME, OR IN THE BAMBOO GROVES OF SAGANO, KYOTO. CAREFULLY SELECTED SOLID WOOD IS FINELY CUT INTO THIN PIECES WITH CHAMFERED CORNERS, WHICH CREATES BEAUTIFUL CONTRASTING SHADES. THE CONTRAST OF LIGHT AND SHADE GIVES THE APPEARANCE THAT THE ACCORDION DOORS FOLD BACK EVEN FURTHER. THE DESIGN INSPIRED BY NATURE, HELPS TO CREATE A COMFORTABLE ATMOSPHERE IN ANY ROOM. WHEN YOU OPEN AND CLOSE THE DOORS, YOU MAY FEEL A SLIGHT STIFFNESS AND HEAR THE SOUND OF THE PIECES OF WOOD RUBBING TOGETHER.

OPENING THE DOOR REQUIRES SOME PATIENCE! HOWEVER, ON OPENING THE CABINET, YOUR PATIENCE IS REWARDED BECAUSE OF THE HIDDEN AND ENCHANTING CHARM DISPLAYED WITHIN THIS PIECE OF FURNITURE. THE JABARA AV BOARD IS AVAILABLE IN THREE DIFFERENT HEIGHTS AND FIVE WIDTHS. THESE PARTS CAN BE ASSEMBLED INTO 15 DIFFERENT ARRANGEMENTS, THEREBY CATERING FOR DIFFERING TASTES AND LIFESTYLES. THE SMOKED-GLASS DOOR HIDES AWAY ANY AUDIO-VISUAL EQUIPMENT. IN COMBINATION WITH THE ATTRACTIVE ACCORDION-STYLE DOOR, THE STYLISH APPEARANCE OF THE SMOKED-GLASS DOOR CREATES A MODERN BUT WARM ATMOSPHERE. WE ARE COMMITTED TO MAKING PRODUCTS WHICH COMBINE BOTH BEAUTY AND PRACTICALITY. IN THIS WAY, OUR CUSTOMERS CAN ENJOY ATTRACTIVELY DESIGNED PIECES OF FURNITURE FOR STORING ITEMS.



**JABARA
AV BOARD (TYPE H)**

W2200xD455xH600
ITEM NO. JAV2212
OAK (URETHANE FINISH WH)



**JABARA
AV BOARD (TYPE L)**

W2200xD455xH460
ITEM NO. JAV2191
WALNUT (URETHANE FINISH NL)



**JABARA
AV BOARD (TYPE L)**

W1800xD455xH460
ITEM NO. JAV2185
WALNUT (URETHANE FINISH NL)



**JABARA
AV BOARD (TYPE D)**

W2400xD455xH370
ITEM NO. JAV2173
WALNUT (URETHANE FINISH NL)



SPECIFICATION

[DESCRIPTION]

BODY FRAME : YOU CAN CHOOSE FROM THE FOLLOWING ;
WALNUT (URETHANE FINISH NL)
OAK (URETHANE FINISH NL / WH)

GLASS DOOR : SMOKED GLASS / FRAME (BLACK)

BASE : BLOCK BOARD WITH BLACK LAMINATED POLYESTER (FOR BASE TYPE D)
STEEL POWDER COATING WITH BLACK (FOR BASE TYPE H & TYPE L)
HAIRLINE STAINLESS STEEL ACRYLIC URETHANE COATING WITH
6 COLORS (UPGRADE FOR BASE TYPE H & TYPE L)

WIRING BOX : STEEL POWDER COATING WITH BLACK
INNER BOX : LEATHER (LE-8010) / ARTIFICIAL SUEDE (GREIGE)

[LOAD LIMIT]

BODY : W1600 / 80kg, W1800 / 90kg, W2000 / 100kg, W2200 / 110kg, W2400 / 120kg
TOP PANEL : UNDER W1800 / 35kg, OVER W2000 / 45kg
SHELF : 10kg

[NOTICE]

- PLEASE USE THE ATTACHED FURNITURE FALL PREVENTION FITTINGS FOR TYPE H.
- READY-TO-ASSEMBLE BASE
- ONE SHELF BOARD IS PROVIDED FOR EACH STORAGE COMPARTMENT

[AWARD]

RED DOT DESIGN AWARD 2019 BEST OF THE BEST



reddot design award
best of the best 2019

FEATURES

WOOD AND COLOR VARIATION

PLEASE SELECT ONE OF THE TWO TYPES OF WOOD (WALNUT/OAK)
WALNUT COMES IN NL (NATURAL COLOR).
OAK COMES IN TWO COLORS, NL AND WH (WHITE).

WALNUT
(URETHANE NL)

OAK
(URETHANE NL)

OAK
(URETHANE WH)

JABARA SLIDING DOOR

NATURAL WOOD IS FINELY CUT INTO PIECES WITH CHAMFERED CORNERS AND THEY ARE CAREFULLY ARRANGED TO PERFECTLY COORDINATE WITH ONE ANOTHER IN COLORS AND GRAINS. THIS ENHANCES THE DELICATE BEAUTY OF THIS ACCORDION-STYLE JABARA DOOR.
NATURAL WOOD ASSUMES A VARIETY OF EXPRESSIONS BECAUSE OF ITS RICH TEXTURE. IN ADDITION, IT IS PLEASANT TO FEEL THE TOUCH OF THIS UNIQUE DOOR, SUCH AS A SLIGHT STIFFNESS AND THE SOUND OF THE PIECES OF WOOD RUBBING TOGETHER WHEN YOU OPEN AND CLOSE THE DOOR.

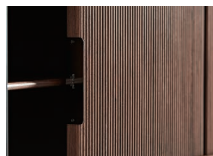

GLASS DOOR

THE AV EQUIPMENT STORAGE SPACE IS ENCLOSED IN SMOKED GLASS SO THAT EQUIPMENT IS STORED DISCRETELY. THE HANDLE IS SLIM AND INTEGRATED INTO THE UPPER DOOR FRAME IN ORDER NOT TO DISTURB THE BEAUTY OF THE FLAT DOOR FACE.
PLEASE ENJOY A CALM AND MODERN ATMOSPHERE CREATED BY THE SOPHISTICATED COMBINATION OF SMOKED GLASS AND DELICATE JABARA.

※A REMOTE CONTROL IS OPERABLE WITH THE GLASS DOOR CLOSED.



INNER BOX (OPTION)

INNER BOXES FOR THE STORAGE COMPARTMENTS ARE AVAILABLE. THEIR BASE IS UPHOLSTERED WITH ELEGANT SEMI-ANILINE NATURAL LEATHER, AND THE INSIDE IS LINED WITH ARTIFICIAL SUEDE TO PREVENT YOUR PRECIOUS ITEMS FROM GETTING SCRATCHED.



BASE

THERE ARE THREE TYPES OF BASE: TYPE H STEEL BASE (BASE: H270), TYPE L STEEL BASE (BASE: H130), AND TYPE D WITH ARCHITRAVE (ARCHITRAVE: H40). BASE OF DIFFERENT HEIGHTS ARE AVAILABLE FOR EACH BODY TYPE. PLEASE SELECT THE TYPE THAT BEST MATCHES THE INTERIOR OF YOUR ROOM AND YOUR LIFESTYLE.

※A ROBOT CLEANER CAN EASILY MOVE AROUND UNDER THE AV BOARD WITH STEEL BASE. (240MM CLEARANCE FOR TYPE H, AND 100MM CLEARANCE FOR TYPE L)

















TYPE H



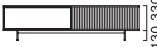

TYPE L

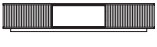



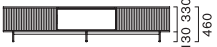
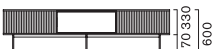
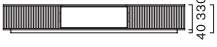
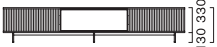

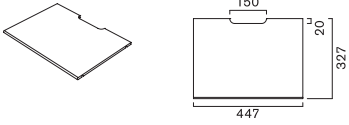

TYPE D

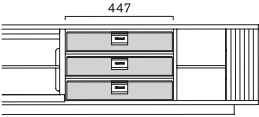
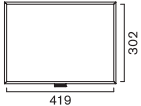
ITEM	WIDE	TYPE	SIZE [mm]	ITEM NO.	WOOD AND COLOR
BODY	W1600	D	(L) 	JAV 2161 (L)	WALNUT (URETHANE NL)
			(R) 	JAV 2163 (R)	
		W1600xD455xH370	JAV 2162 (L)	OAK (URETHANE NL)	OAK (URETHANE WH)
	JAV 2164 (R)				
	L	(L) 	JAV 2181 (L)	WALNUT (URETHANE NL)	
		(R) 	JAV 2183 (R)		
	W1600xD455xH460	JAV 2182 (L)	OAK (URETHANE NL)	OAK (URETHANE WH)	
	JAV 2184 (R)				
	H	(L) 	JAV 2201 (L)	WALNUT (URETHANE NL)	
(R) 		JAV 2203 (R)			
W1600xD455xH600	JAV 2202 (L)	OAK (URETHANE NL)	OAK (URETHANE WH)		
JAV 2204 (R)					
W1800	D	(L) 	JAV 2165 (L)	WALNUT (URETHANE NL)	
		(R) 	JAV 2167 (R)		
		W1800xD455xH370	JAV 2166 (L)	OAK (URETHANE NL)	OAK (URETHANE WH)
	JAV 2168 (R)				
	L	(L) 	JAV 2185 (L)	WALNUT (URETHANE NL)	
		(R) 	JAV 2187 (R)		
	W1800xD455xH460	JAV 2186 (L)	OAK (URETHANE NL)	OAK (URETHANE WH)	
	JAV 2188 (R)				
	H	(L) 	JAV 2205 (L)	WALNUT (URETHANE NL)	
(R) 		JAV 2207 (R)			
W1800xD455xH600	JAV 2206 (L)	OAK (URETHANE NL)	OAK (URETHANE WH)		
JAV 2208 (R)					
W2000	D	(L) 	JAV 2169	WALNUT (URETHANE NL)	
			JAV 2170		OAK (URETHANE NL)
	L	(L) 	JAV 2189	WALNUT (URETHANE NL)	
			JAV 2190		OAK (URETHANE NL)
	H	(L) 	JAV 2209	WALNUT (URETHANE NL)	
			JAV 2210		OAK (URETHANE NL)

ITEM	WIDE	TYPE	SIZE [mm]	ITEM NO.	WOOD AND COLOR
BODY	W2200	D	 W2200x455xH370	JAV 2171	■ WALNUT (URETHANE NL)
		JAV 2172	■ OAK (URETHANE NL) ■ OAK (URETHANE WH)		
		L	 W2200x455xH460	JAV 2191	■ WALNUT (URETHANE NL)
	JAV 2192	■ OAK (URETHANE NL) ■ OAK (URETHANE WH)			
	H	 W2200x455xH600	JAV 2211	■ WALNUT (URETHANE NL)	
	JAV 2212	■ OAK (URETHANE NL) ■ OAK (URETHANE WH)			
	W2400	D	 W2400x455xH370	JAV 2173	■ WALNUT (URETHANE NL)
		JAV 2174	■ OAK (URETHANE NL) ■ OAK (URETHANE WH)		
		L	 W2400x455xH460	JAV 2193	■ WALNUT (URETHANE NL)
JAV 2194		■ OAK (URETHANE NL) ■ OAK (URETHANE WH)			
H		 W2400x455xH600	JAV 2213	■ WALNUT (URETHANE NL)	
JAV 2214		■ OAK (URETHANE NL) ■ OAK (URETHANE WH)			

OPTION ITEM	SIZE [mm]	ITEM NO.	WOOD AND COLOR / INNER BOX MATERIAL
SHELF PLATE	 W447x327xT10	JB 2221	■ WALNUT (URETHANE NL)
		JB 2222	■ OAK (URETHANE NL) ■ OAK (URETHANE WH)

INNER BOX	SIZE [mm]	ITEM NO.	WOOD AND COLOR / INNER BOX MATERIAL
LIB 2223 ※THE PART COLORED IN GRAY OF THE SINGLE VIEW DRAWING. AN EXAMPLE OF INNER BOX ARRANGEMENT 	 W437x320xH80 ※INSIDE H72	LIB 2223	■ LEATHER (LE-8010) ■ ARTIFICIAL SUEDE (GREIGE) ※IMAGES COLORED IN GRAY IN THREE-DIMENSIONAL DRAWINGS

ITEM	SPECIFICATION	ITEM NO.	TARGET ITEM NO.
BASE (UPGRADE)	YOU CAN UPGRADE FROM STEEL BASE TO HAIRLINE STAINLESS STEEL ACRYLIC URETHANE COATING WITH 6 COLORS (SHINY HAIRLINE / SHINY BRASS / SHINY BRONZE / ANTIQUE BRASS / ANTIQUE GRAY / CLASSIC ROSE)	JB 2234	W1600 · L JAB 2181 / 2182 / 2183 / 2184
		JB 2235	W1800 · L JAB 2185 / 2186 / 2187 / 2188
	 HAIRLINE STAINLESS STEEL (SHINY HAIRLINE)	JB 2236	W2000 · L JAB 2189 / 2190
	 HAIRLINE STAINLESS STEEL (SHINY BRASS)	JB 2237	W2200 · L JAB 2191 / 2192
	 HAIRLINE STAINLESS STEEL (SHINY BRONZE)	JB 2238	W2400 · L JAB 2193 / 2194
	 HAIRLINE STAINLESS STEEL (ANTIQUÉ BRASS)	JB 2239	W1600 · H JAB 2201 / 2202 / 2203 / 2204
	 HAIRLINE STAINLESS STEEL (ANTIQUÉ GRAY)	JB 2240	W1800 · H JAB 2205 / 2206 / 2207 / 2208
	 HAIRLINE STAINLESS STEEL (CLASSIC ROSE)	JB 2241	W2000 · H JAB 2209 / 2210
		JB 2242	W2200 · H JAB 2211 / 2212
		JB 2243	W2400 · H JAB 2213 / 2214

DETAILS



THE DROP-DOWN DOOR SLOWLY OPENS AND CLOSES WITH A FEELING OF MODERATE RESISTANCE. QUALITY WIRE STAY AND SOFT CLOSE DAMPER ARE USED TO ACHIEVE SMOOTHER OPERABILITY. BY USING INCONSPICUOUS PARTS AND EMPHASIZING THEIR PERFECT FIT, THE DOOR IS HIGHLY FUNCTIONAL AND STYLISH IN DESIGN.

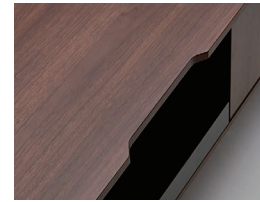

A SECTION OF THE REAR END OF THE TOP OF THE AV BOARD IS CUT OUT (W200XD14) FOR WIRING. THIS ALLOWS CORDS TO BE DRAWN OUT NEATLY AND THE AV BOARD TO BE PLACED FLUSH UP AGAINST THE WALL.



THIS AV BOARD HAS STORAGE SPACE FOR VERTICAL EQUIPMENT SUCH AS A HARD DISK AND A ROUTER.



THE WIRING BOX (W525XD70XH70) IS DESIGNED TO ORDERLY ACCOMMODATE POWER STRIPS AND EXTRA CORDS.



ONE MOVABLE SHELF BOARD IS PROVIDED FOR EACH STORAGE COMPARTMENT. THE HEIGHT CAN BE ADJUSTED EVERY 50MM.



THERE IS A LITTLE LARGER OPENING FOR WIRING IN THE BACK OF THE STORAGE COMPARTMENT, AND A BACK BOARD IS ATTACHED TO HIDE THE WIRING.



THE PARTITION BOARD FOR THE STORAGE COMPARTMENT HAS AN OPENING (W55XH40). CABLES CAN BE LAID THROUGH ALL THE STORAGE SPACES.



THE BACK BOARD IS REMOVABLE. THE BACK BOARD CAN BE REMOVED SO THAT EQUIPMENT IS EASILY PUT IN AND OUT FROM THE BACK. IT ALSO FACILITATES COMPLICATED WIRING WORK.



THE REAR END OF THE TOP BOARD OF THE BODY IS 15MM LONGER THAN THE REST OF THE BODY IN ORDER TO CLOSE THE GAP BETWEEN THE WALL AND THE BODY THAT IS CREATED BY THE BASEBOARD OF A ROOM. THEREFORE THE AV BOARD CAN BE PLACED FLUSH UP AGAINST THE WALL.

WIRING

A WIRING SPACE IS PROVIDED AT THE BACK OF THE BODY, AND EACH OF SHELF BOARDS AND PARTITION BOARDS HAS AN OPENING FOR WIRING. THIS FACILITATES EQUIPMENT INSTALLATION AND WIRING, AND NEATLY ACCOMMODATES POWER STRIPS AND CORDS.

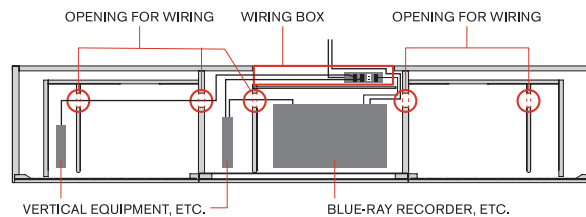

CROSS SECTION (TOP)

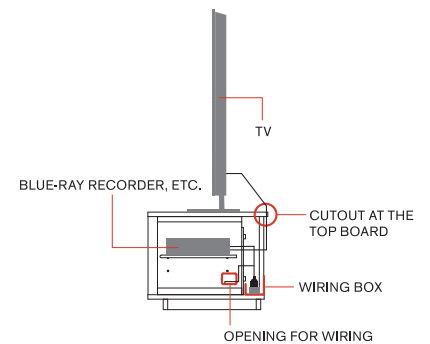

CROSS SECTION (SIDE)

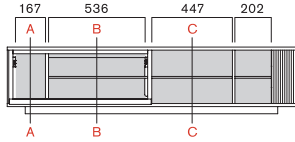
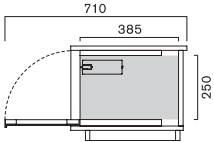
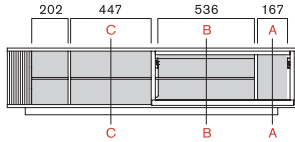
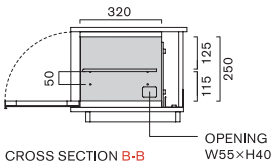
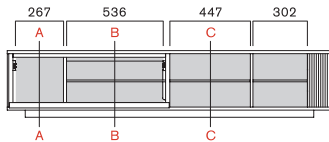
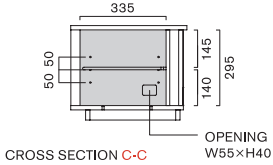
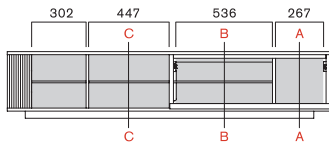
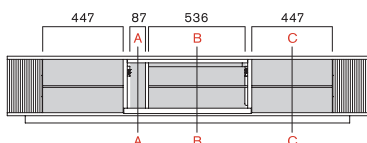
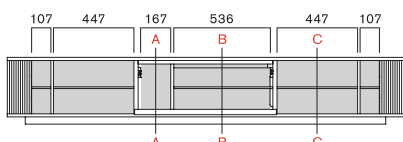
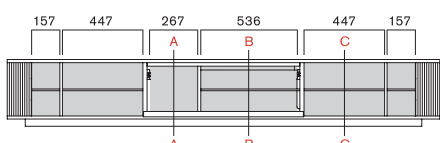
USABLE DIMENSION	TYPE	ITEM NO.	SIZE [mm]													
INSIDE	W1600 (L)	JAV 2161														
		JAV 2162														
		JAV 2181														
		JAV 2182														
		JAV 2201														
		JAV 2202														
		CROSS SECTION A-A														
W1600 (R)	JAV 2163 JAV 2164 JAV 2183 JAV 2184 JAV 2203 JAV 2204															
				CROSS SECTION B-B												
				W1800 (L)	JAV 2165 JAV 2166 JAV 2185 JAV 2186 JAV 2205 JAV 2206											
								CROSS SECTION C-C								
								W1800 (R)	JAV 2167 JAV 2168 JAV 2187 JAV 2188 JAV 2207 JAV 2208							
											W2000	JAV 2169 JAV 2170 JAV 2189 JAV 2190 JAV 2209 JAV 2210				
														W2200	JAV 2171 JAV 2172 JAV 2191 JAV 2192 JAV 2211 JAV 2212	
W2400	JAV 2173 JAV 2174 JAV 2193 JAV 2194 JAV 2213 JAV 2214															

BACK DETAILS

BEHIND THE BACK BOARD INSTALLED IN THE BACK OF THE BODY, THERE IS A SPACE TO ORDERLY ACCOMMODATE WIRING CORDS AND POWER STRIPS. AND ALSO TO INSTALL THE WIRING BOX. THE BACK BOARD CAN BE EASILY REMOVED AND INSTALLED WITHOUT USING ANY TOOL.

※FIXTURES (SCREWS) CAN BE EASILY TAKEN OFF BY HAND.

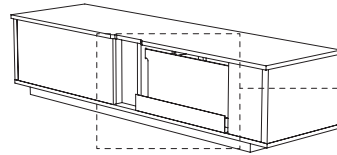

REFERENCE DRAWING :
JAV 2161 (L) / JAV 2162 (L)

BACK BOARD REMOVAL PROCEDURE

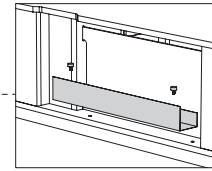

REMOVE THE SCREWS AT BOTH ENDS OF THE WIRING BOX.

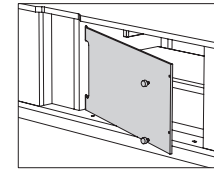

REMOVE THE SCREW AT THE RIGHT END OF THE BACK BOARD, AND PULL OUT THE BOARD TOWARD YOU IN A RIGHT OBLIQUE DIRECTION TO REMOVE THE BOARD.

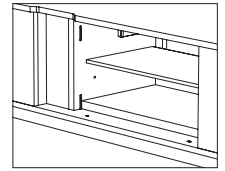

USABLE DIMENSION

ELECTRIC OUTLET POSITION

TO THOSE WHO ARE BUILDING A HOUSE AND NEED TO DECIDE THE POSITION OF THE ELECTRICAL OUTLET FOR THE AV BOARD: POSITION THE OUTLET SO THAT IT IS FACING THE OPENING BEHIND THE BACK BOARD (GRAY AREA IN THE DRAWING). THEN PLACE THE AV BOARD UP AGAINST THE WALL.

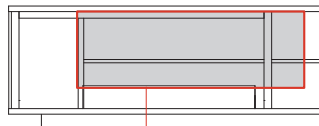

PLEASE ARRANGE THE OUTLET PLATE TO COME WITHIN THE GRAY AREA.



OUTLET PLATE

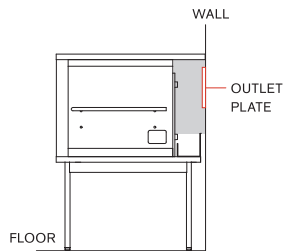

CROSS SECTION (SIDE)

TYPE	ITEM NO.
W1600 (L)	JAV 2161
	JAV 2162
	JAV 2181
	JAV 2182
	JAV 2201
	JAV 2202
W1600 (R)	JAV 2163
	JAV 2164
	JAV 2183
	JAV 2184
	JAV 2203
	JAV 2204
W1800 (L)	JAV 2165
	JAV 2166
	JAV 2185
	JAV 2186
	JAV 2205
	JAV 2206
W1800 (R)	JAV 2167
	JAV 2168
	JAV 2187
	JAV 2188
	JAV 2207
	JAV 2208
W2000	JAV 2169
	JAV 2170
	JAV 2189
	JAV 2190
	JAV 2209
	JAV 2210
W2200	JAV 2171
	JAV 2172
	JAV 2191
	JAV 2192
	JAV 2211
	JAV 2212
W2400	JAV 2173
	JAV 2174
	JAV 2193
	JAV 2194
	JAV 2213
	JAV 2214

SIZE [mm]

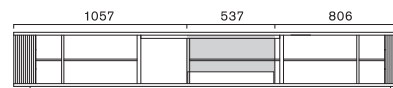
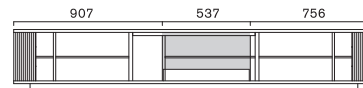
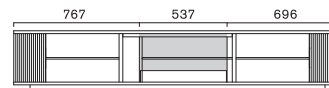
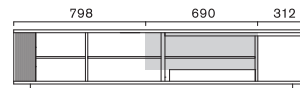
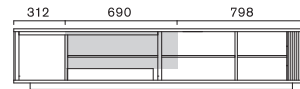
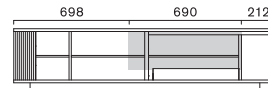
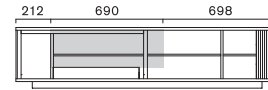

THE HEIGHT FROM THE FLOOR TO THE OPENING (THE GRAY AREA) WILL VARY ACCORDING TO THE BASE TYPE.

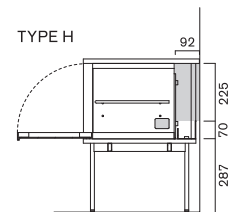
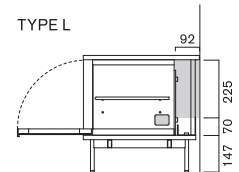
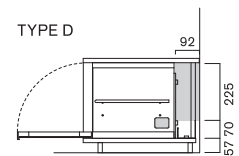

TV SETTING EXAMPLE

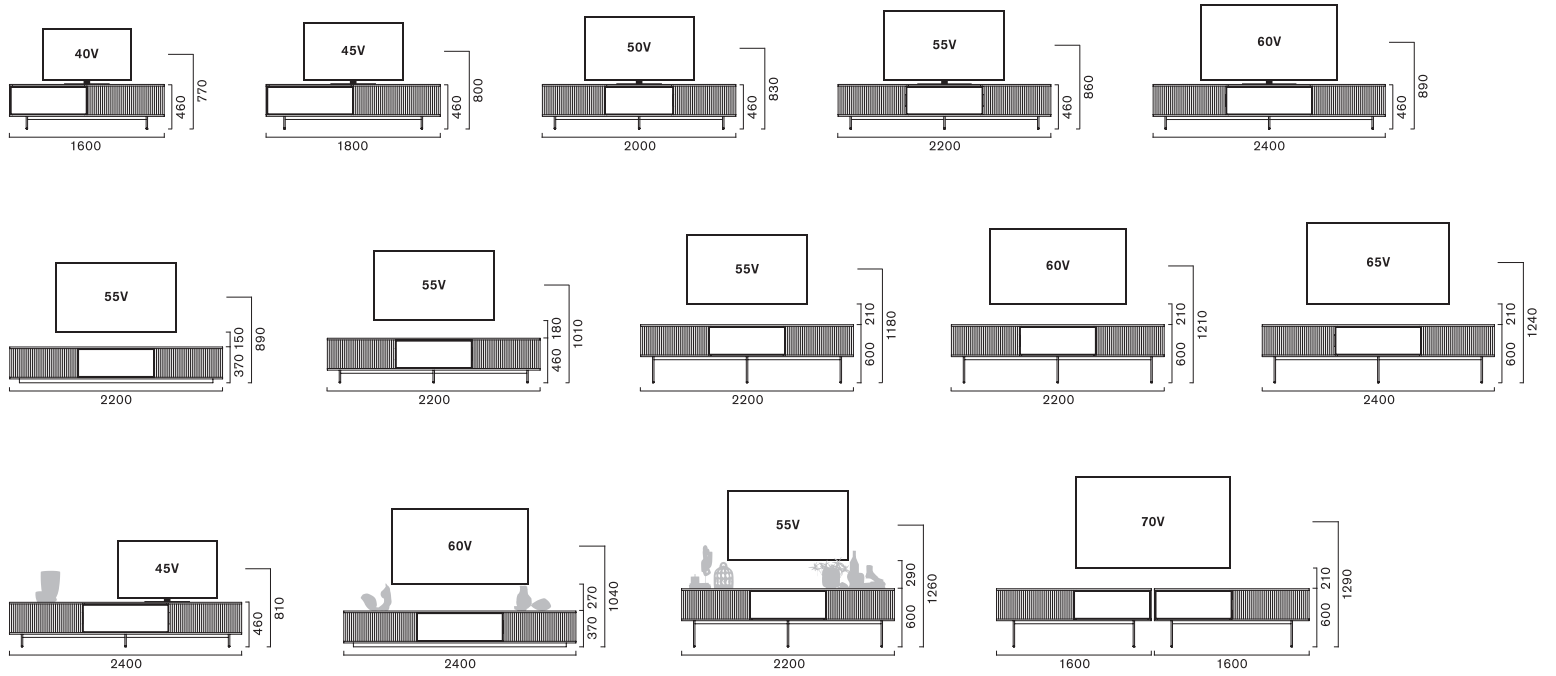

※ A COMFORTABLE VIEWING ENVIRONMENT FOR CUSTOMERS IS DETERMINED BY ROOM SIZE, FURNITURE LAYOUT, AND THE USE ENVIRONMENT. CONSIDER THE SCREEN SIZE OF YOUR TV, ROOM DÉCOR, AND YOUR LIFESTYLE, BEFORE SELECTING THE RIGHT TYPE OF AV BOARD FOR YOU.