



Struttura: in legno multistrato di vari spessori. Preparazione della struttura sedile in poliuretano espanso ad alta resilienza composta da numerosi strati di quote differenziate. La struttura del sedile è rivestita da un trapuntino di piuma d'oca canalizzata ad alto spessore, per conferire grande soffici ta ed aumentare il comfort. La piuma   sottoposta a regolare trattamento di bonifica igienico-sanitaria come stabilito da Regolamento CE 1069/2009 (certificata Assopiuma, Etichetta Oro). Successivamente il trapuntino   rivestito da fibra termolegata traspirante accoppiata con tela di cotone bianca anallergica. Preparazione della struttura dei braccioli e degli schienali in poliuretano espanso a quote differenziate ad alta densit , successivamente rivestiti con un trapuntino di fibra poliestere termolegata traspirante accoppiata con tela di cotone bianca. Tutti i materiali impiegati per realizzare il trapuntino sono anallergici. La confezione di tutte le fodere (sedile/schienale/braccioli)   caratterizzata da cuciture asimmetriche che uniscono, attraverso una caratteristica doppia cucitura, le varie parti di tessuto o pelle precedentemente accoppiate ad una fibra termolegata con la tela di cotone bianca.

La particolare confezione   contraddistinta ulteriormente da un profilo, che esalta il grafismo *couturier*, tratto distintivo del sistema.

Cuscineria: imbottitura cuscini schienali in piuma d'oca canalizzata con inserto in poliuretano espanso ad alta resilienza in materiale termosensibile.

Sfoderabilit : completamente sfoderabile in tutte le versioni (tessuto o pelle).

Piedini: principali e portanti in estruso di alluminio romato oppure verniciato colore Black Coffee con finitura lucida anti-touch. L'appoggio a terra   inoltre garantito da piedini in metallo verniciati lucido anti-touch color nero. Scivolante protettivo in SEBS e polietilene di colore nero.

Pouf   104, 84 e 64 cm: base in metallo finitura Cromo o verniciato colore Black Coffee con finitura lucida anti-touch. Appoggio a terra mezzo ruote con struttura in nylon e gomma in poliuretano termoplastico.

Per facilitare la sfoderabilit  e la consegna, gli schienali e i braccioli sono sfilabili dalla base tramite un sistema di innesto e sgancio rapido, prima rimuovere i piedini.

Structure: in plywood of various thicknesses. The seat structure is made of numerous layers of variable-density high-resilience polyurethane foam. Seat structure is covered in lightweight quilted material filled with high-loft channelled goose-down padding, to lend greater softness and increase comfort. The down undergoes routine sanitization as specified in EC Regulation No. 1069/2009 (Assopiuma Gold Label certified). The quilted padding is then encased in breathable heat-bonded fibre laminated to white hypoallergenic cotton fabric.

The armrest and backrest structures are composed of variable-density high-resilience polyurethane foam, then encased in quilted breathable heat-bonded polyester fibre laminated to white cotton canvas fabric.

All materials employed in manufacturing the quilted padding are hypoallergenic.

Tailoring of all the upholstery (seat/backrest/armrests) is characterised by asymmetrical double-stitched seams that join the various pieces of fabric or leather previously laminated to heat-bonded fibre with the white cotton fabric.

This singular tailoring process is further distinguished by piping, which enhances the haute couture aspect of the workmanship, a distinctive trait of the system.

Cushions: backrest cushion padding in channelled goose down with insert in high-resilience polyurethane foam encased in temperature-sensitive material.

Covers: upholstery is completely removable in all versions (fabric and leather).

Feet: primary and weight-bearing, in extruded chromed aluminium or varnished polished Black Coffee colour with glossy anti-fingerprint finish. Support is further guaranteed by metal feet with varnished polished anti-fingerprint black colour finish. Black protective SEBS and polyethylene glides.

Ottomans   104, 84 e 64 cm: base in metal Chrome finish or varnished polished Black Coffee colour with glossy anti-fingerprint finish. Rests on castors with structure in nylon and thermoplastic polyurethane rubber.

To facilitate transport and upholstery removal, the backrests and armrests can be removed from the base through a system of quick set and release closures; remove the feet first.

Struktur: Aus Sperrholz mit unterschiedlichen St rken. Polsterung der Struktur der Sitzfl che aus hochwiderstandsf higem PU-Schaum, der aus zahlreichen Schichten mit differenzierter Dichte besteht.

Die Struktur der Sitzfl che verf gt  ber eine gesteppte Polsterung mit Daunenf llung mit Kammern und Innenstegen mit hoher St rke f r weiche Kissen und mehr Sitzkomfort.

Die Daunen werden nach Vorgabe der Verordnung (EU) 1069/2009 unterzogen (zertifiziert Assopiuma, "Goldenes Etikett") ordnungsgem  sterilisiert. Die gesteppte Polsterung verf gt  ber eine zus tzliche

Polsterung aus atmungsaktiver, thermobondierter Faser mit Bezug aus wei er, antiallergischer Baumwolle. Polsterung die Struktur der Armlehnen und R ckenlehnen aus PU-Schaum mit differenzierter, hoher Dichte und zus tzlicher Polsterung aus atmungsaktiver, thermobondierter

Polyesterfaser mit Bezug aus wei er Baumwolle. Alle, f r die gesteppte Polsterung verwendeten Materialien sind antiallergisch.

Die Konfektionierung aller Bez ge (Sitz/R ckenlehne/Armlehnen) ist durch asymmetrische N hte charakterisiert, die die verschiedenen, auf eine Unterlage aus thermobondierter Faser mit Bezug aus wei er Baumwolle aufgebrachten Stoff- oder Lederteile mit der charakteristischen Doppelnaht miteinander verbinden.

Die besondere Konfektionierung zeichnet sich au erdem durch ihr Couture-Design aus, das ein Erkennungsmerkmal dieses Sofasystems ist.

Kissen: F llung der R ckenkissen mit gesteppter Daunenf llung mit Kammern und Innenstegen und Einsatz aus hochwiderstandsf higem PU-Schaum aus thermosensitivem Material.

Abziehbarkeit: Komplet abziehbar in allen Versionen (Stoff oder Leder).

F  e: Tragende Hauptf  e aus extrudiertem, verchromtem Aluminium, oder mit gl nzender Anti-Touch-Lackierung in der Farbe Black Coffee. Auflage auf dem Boden mit Metallf  en mit gl nzender Anti-Fingerprint-Lackierung in der Farbe Schwarz. Schutzgleiter aus SEBS und Polyethylen in Schwarz.

Hocker   104, 84 e 64 cm: Basis aus Metall mit verchromter Oberfl che oder mit gl nzender Anti-Touch-Lackierung in der Farbe Black Coffee. Auflage auf dem Boden mit Rollen mit Nylonstruktur und thermoplastischem Polyurethan-Gummi.

F r ein einfaches Abziehen vom Bezug und Transportieren des Sofas k nnen die R ckenlehnen und Armlehnen mit einem Schnellkupplungssystem vom Untergestell abgenommen werden, bevor die F  e abgenommen werden.

Pour faciliter le d housseage et la livraison, les dossiers et les accoudoirs peuvent  tre retir s du pi tement gr ce   un syst me d'enclenchement et de d senclenchement rapide; commencer par enlever les pieds.

Structure : en bois multiplis de diff rentes  paisseurs. Pr paration de la structure de l'assise en mousse polyur thane haute r silience compos e de plusieurs couches   densit  diff renci e.

La structure de l'assise est recouverte d'un rembourrage en plume d'oie cloisonn e de forte  paisseur qui lui apporte plus de moelleux et de confort. La plume est soumise   un traitement d'assainissement conform ment au r glement CE 1069/2009 (Certifi e Assopiuma, Label Or). Le rembourrage est ensuite recouvert d'un tissu multicouche en fibre thermocoll e respirante et toile en coton blanc hypoallerg nique.

Pr paration de la structure des accoudoirs et des dossiers en mousse polyur thane   densit  diff renci e haute densit , recouverte ensuite d'un tissu multicouche matelass  en fibre de polyester thermocoll e respirante et toile en coton blanc. Tous les mat riaux utilis s pour r aliser ce rembourrage sont hypoallerg niques.

La confection de toutes les housses (assise/ dossier/accoudoirs) est caract ris e par des coutures asym triques qui unissent les diff rentes pi ces de tissu ou de cuir pr alablement coupl es   un tissu multicouche en fibre thermocoll e et toile en coton blanc, au moyen d'une double surpiq re caract ristique.

Cette confection particuli re se d marque  galement par un passepoil qui met en valeur le style haute couture du syst me.

Coussins : rembourrage des coussins de dossier en plume d'oie cloisonn e avec insert en mousse polyur thane haute r silience en mat riaux thermosensibles.

D housseage : enti rement d housseable dans toutes les versions (tissu ou cuir).

Pieds : principaux et porteurs en aluminium extrud  Chrom  ou peint couleur Black Coffee finition brillante anti-traces, termin s par des embouts de pieds en m tal peint en noir brillant anti-traces. Patins glisseurs en SEBS et poly thyl ne noir.

Pouf   104, 84 e 64 cm : base en m tal finition Chrome ou peint couleur Black Coffee finition brillante anti-traces. Repose sur des roues avec une structure en nylon et polyur thane thermoplastique.

Pour faciliter le d housseage et la livraison, les dossiers et les accoudoirs peuvent  tre retir s du pi tement gr ce   un syst me d'enclenchement et de d senclenchement rapide; commencer par enlever les pieds.

Minotti

AVVERTENZE SUL LAVAGGIO DELLE FODERE

Data la particolare confezione delle fodere, per tutti i tessuti indoor in Collezione e per qualsiasi tipologia di tessuto cliente (compresi quelli lavabili ad acqua), si raccomanda esclusivamente un lavaggio a secco extra soft con azione meccanica ridotta. Non utilizzare asciugatrice.

OPZIONE ALTEZZA PIEDINI

A richiesta sono disponibili, con sovrapprezzo, piedini H 10,5 cm ovvero più alti di 4 cm rispetto ai piedini di serie.

COVER WASHING INSTRUCTIONS

Due to the special crafting process used to make the covers, only extra-soft dry cleaning with reduced mechanical action is recommended for all indoor fabrics in the Collection and for any type of customer fabric (including water-washable fabrics). Do not tumble dry.

FEET HEIGHT OPTIONS

Available upon request, 10,5 cm high feet, with surcharge; 4 cm higher than the standard feet.

HINWEISE ZUR REINIGUNG DER BEZÜGE

Aufgrund der besonderen Anfertigung der Bezüge wird für alle Indoor-Stoffe der Kollektion und jede Art von Kundenstoff (auch wenn mit Wasser waschbar) ausschließlich eine extra-sanfte Trockenreinigung mit geringer mechanischer Einwirkung empfohlen. Nicht in den Trockner geben.

OPTION HÖHE DER FÜSSE

Auf Anfrage hin ist, mit Aufpreis, die 10,5 cm hohe Füße erhältlich, also 4 cm höher als die serienmäßige Ausführung.

AVERTISSEMENTS RELATIF AU NETTOYAGE DES HOUSES

Compte tenu du mode de confection particulier des housses, pour tous les tissus intérieurs de la Collection ainsi que pour toute typologie de tissu client (y compris ceux lavables à l'eau), il est conseillé de procéder exclusivement à un nettoyage à sec ultra délicat avec action mécanique réduite. Ne pas mettre au sèche-linge.

OPTION HAUTEUR DES PIEDS

Des pieds H 10,5 cm, à savoir 4 cm plus hauts que les pieds de série, sont disponibles sur demande, avec supplément.

ALTEZZA BRACCIOLI | ARMRESTS HEIGHT

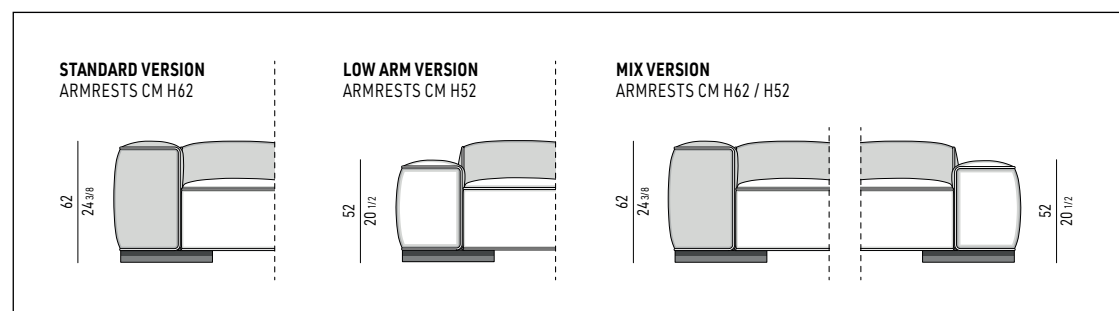

ALTEZZA PIEDINI | FEET HEIGHT

PIEDINI | FEET **CM 6,5**

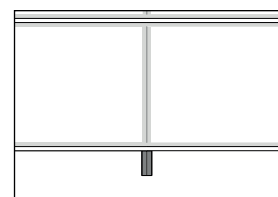

PIEDINI | FEET **CM 10,5**

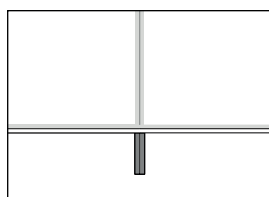

PIEDINI FEET

ALLUMINIO LUCIDO
POLISHED ALUMINIUM



CROMO
CHROME

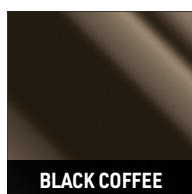

BLACK COFFEE

VERSIONE **CROMO**
CHROME VERSION



VERSIONE **BLACK COFFEE**
BLACK COFFEE VERSION





Struttura: in legno multistrato di vari spessori. Preparazione della struttura sedile, braccioli e schienali in poliuretano espanso a quote differenziate ad alta densità, rivestiti successivamente con trapuntino di fibra poliestere termolegata traspirante accoppiata con tela di cotone bianca. Tutti i materiali impiegati per realizzare il trapuntino sono anallergici. Struttura sedile realizzata con sede concava per accogliere il cuscino sedile. La confezione di tutte le fodere (base/schienale/braccioli e cuscino sedile) è caratterizzata da cuciture asimmetriche che uniscono, attraverso una caratteristica doppia cucitura, le varie parti di tessuto o pelle precedentemente accoppiate ad una fibra termolegata con la tela di cotone bianca.

La particolare confezione è contraddistinta ulteriormente da un profilo, che esalta il grafismo couturier, tratto distintivo del sistema.

Cuscineria: imbottitura cuscini sedile e schienale in piuma d'oca canalizzata ad alto spessore, per conferire grande sofficià ed aumentare il comfort, sottoposta a regolare trattamento di bonifica igienico-sanitaria come stabilito da Regolamento CE 1069/2009 (certificata Assopiuma, Etichetta Oro). I cuscini sono successivamente rivestiti da fibra termolegata traspirante accoppiata con tela di cotone bianca anallergica.

Cuscini sedile e schienale con inserto in poliuretano espanso a quote differenziate ad alta resilienza in materiale termosensibile. Il poliuretano espanso contenuto nel cuscino sedile è sagomato per adattarsi perfettamente alle doppie cuciture asimmetriche che accoppiano tra loro le varie parti di tessuto tramite una doppia cucitura. Inserto centrale composto da molle d'acciaio insacchettate che garantiscono l'indeformabilità della seduta e un maggiore comfort.

Sfoderabilità: completamente sfoderabile in tutte le versioni (tessuto o pelle).

Piedini: principali e portanti in estruso di alluminio Cromato oppure verniciato colore Black Coffee con finitura lucida anti-touch. L'appoggio a terra è inoltre garantito da piedini in metallo verniciati lucido anti-touch color nero. Scivolante protettivo in SEBS e polietilene di colore nero.

Per facilitare la sfoderabilità e la consegna, gli schienali e i braccioli sono sfilabili dalla base tramite un sistema di innesto e sgancio rapido, prima rimuovere i piedini.

Structure: in plywood of various thicknesses. The seat, armrest and backrest structures are in high-resilience, variable-density polyurethane foam, then encased in breathable quilted heat-bonded polyester fibre laminated to white cotton fabric. All materials employed in manufacturing the quilted padding are hypoallergenic.

Seat structure is concave to accommodate the seat cushion. Tailoring of all the upholstery (base/backrest/armrests and seat cushion) is characterised by asymmetrical double-stitched seams that join the various pieces of fabric or leather previously laminated to heat-bonded fibre with the white cotton fabric. This singular tailoring process is further distinguished by piping, which enhances the haute couture aspect of the workmanship, a distinctive trait of the system.

Cushions: seat and backrest cushions, padded in high-loft channelled goose down to lend greater softness and increase comfort, undergo routine sanitisation as specified in EC Regulation No. 1069/2009 (Assopiuma Gold Label certified). The cushions are then encased in breathable heat-bonded fibre laminated to white hypoallergenic cotton fabric.

Seat and backrest cushions with high resilience, variable-density polyurethane foam insert in temperature-sensitive material. The polyurethane foam in the seat cushion is contoured to adapt perfectly to the asymmetrical double-stitched seams that join the various parts of the fabric. A core insert made of steel pocket springs ensures non-deformability of the seat and greater comfort.

Covers: upholstery is completely removable in all versions (fabric and leather).

Feet: primary and weight-bearing, in extruded Chromed aluminium or varnished polished Black Coffee colour with glossy anti-fingerprint finish. Support is further guaranteed by metal feet with varnished polished anti-fingerprint black colour finish. Black protective SEBS and polyethylene glides.

To facilitate transport and upholstery removal, the backrests and armrests can be removed from the base through a system of quick set and release closures; remove the feet first.

Struktur: Aus Sperrholz mit unterschiedlichen Stärken. Polsterung der Struktur der Sitzfläche, der Armlehnen und der Rückenlehnen aus PU-Schaum mit differenzierter, hoher Dichte und zusätzlicher gesteppter Polsterung aus atmungsaktiver thermobondierter Polyesterfaser mit Bezug aus weißer Baumwolle. Alle, für die gesteppte Polsterung verwendeten Materialien sind antiallergisch. Struktur der Sitzfläche mit vertieftem Sitz zur Aufnahme des Sitzkissens. Die Konfektionierung aller Bezüge (Basis/Rückenlehne/Armlehnen und Sitzkissen) ist durch asymmetrische Nähte charakterisiert, die die verschiedenen, auf eine Unterlage aus thermobondierter Faser mit Bezug aus weißer Baumwolle aufgebrachten Stoff- oder Lederteile mit der charakteristischen Doppelnaht miteinander verbinden. Die besondere Konfektionierung zeichnet sich außerdem durch ihr Couture-Design aus, das ein Erkennungsmerkmal dieses Sofasystems ist.

Kissen: Rückenkissen und Sitzkissen mit gesteppter Daunenfüllung mit Kammern und Innenstegen mit hoher Stärke für weiche Kissen und mehr Sitzkomfort, die nach Vorgabe der Verordnung (EU) 1069/2009 (zertifiziert Assopiuma, "Goldenes Etikett") ordnungsgemäß sterilisiert worden ist. Zusätzliche Polsterung der Kissen aus atmungsaktiver, thermobondierter Faser mit Bezug aus weißer, antiallergischer Baumwolle. Sitzkissen und Rückenkissen mit Kern aus hochwiderstandsfähigem PU-Schaum mit differenzierter Dichte aus thermosensitivem Material. Der PU-Schaum im Sitzkissen ist geformt, um sich perfekt an die doppelten asymmetrischen Nähte anzupassen, die die verschiedenen Stoffteile des Bezugs mit einer Doppelnaht verbinden. Zentraler Einsatz aus Taschenfederkernen aus Stahl, die für die Formbeständigkeit der Sitzfläche und einen höheren Sitzkomfort garantieren.

Abziehbarkeit: Komplet abziehbar in allen Versionen (Stoff oder Leder).

FüÙe: Tragende HauptfüÙe aus extrudiertem verchromtem Aluminium, oder mit glänzender Anti-Touch-Lackierung in der Farbe Black Coffee. Auflage auf dem Boden mit MetallfüÙen mit glänzender Anti-Fingerprint-Lackierung in der Farbe Schwarz. Schutzgleiter aus SEBS und Polyethylen in Schwarz.

Für ein einfaches Abziehen vom Bezug und Transportieren des Sofas können die Rückenlehnen und Armlehnen mit einem Schnellkupplungssystem vom Untergestell abgenommen werden, bevor die FüÙe abgenommen werden.

Structure : en bois multiplis de différentes épaisseurs. Préparation de la structure de l'assise, des accoudoirs et des dossiers en mousse polyuréthane à densité différenciée haute densité, recouverte ensuite d'un tissu multicouche matelassé en fibre de polyester thermocollée respirante et toile en coton blanc. Tous les matériaux utilisés pour réaliser ce rembourrage sont hypoallergéniques.

Structure de l'assise réalisée avec un logement concave pour accueillir le coussin d'assise. La confection de toutes les housses (base/dossier/accoudoirs et coussin d'assise) est caractérisée par des coutures asymétriques qui unissent les différentes pièces de tissu ou de cuir préalablement couplées à un tissu multicouche en fibre thermocollée et toile en coton blanc, au moyen d'une double surpique caractéristique. Cette confection particulière se démarque également par un passepoil qui met en valeur le style haute couture du système.

Coussins : rembourrage des coussins d'assise et de dossier en plume d'oie cloisonnée de forte épaisseur pour apporter beaucoup de moelleux et augmenter le confort, soumise à un traitement d'assainissement conformément au règlement CE 1069/2009 (Certifiée Assopiuma, Label Or). Par la suite, les coussins sont recouverts d'un tissu multicouche en fibre thermocollée respirante et toile en coton blanc hypoallergénique. Coussins d'assise et de dossier avec insert en mousse polyuréthane à densité différenciée haute résilience en matériau termosensibile.

La mousse polyuréthane contenue dans le coussin d'assise est façonné de façon à s'adapter parfaitement aux doubles coutures asymétriques qui assemblent les différentes pièces de tissu. Insert central composé de ressorts ensachés en acier qui garantissent l'indeformabilité de l'assise et un plus grand confort.

Déhoussage : entièrement déhoussable dans toutes les versions (tissu ou cuir).

Pieds : principaux et porteurs en aluminium extrudé chromé ou peint couleur black coffee finition brillante anti-traces, terminés par des embouts de pieds en métal peint en noir brillant anti-traces. Patins glisseurs en SEBS et polyéthylène noir.

Pour faciliter le déhoussage et la livraison, les dossiers et les accoudoirs peuvent être retirés du piètement grâce à un système d'enclenchement et de désenclenchement rapide ; commencer par enlever les embouts de pieds.

Minotti

AVVERTENZE SUL LAVAGGIO DELLE FODERE

Data la particolare confezione delle fodere, per tutti i tessuti indoor in Collezione e per qualsiasi tipologia di tessuto cliente (compresi quelli lavabili ad acqua), si raccomanda esclusivamente un lavaggio a secco extra soft con azione meccanica ridotta. Non utilizzare asciugatrice.

OPZIONE ALTEZZA PIEDINI

A richiesta sono disponibili, con sovrapprezzo, piedini H 10,5 cm ovvero più alti di 4 cm rispetto ai piedini di serie.

COVER WASHING INSTRUCTIONS

Due to the special crafting process used to make the covers, only extra-soft dry cleaning with reduced mechanical action is recommended for all indoor fabrics in the Collection and for any type of customer fabric (including water-washable fabrics). Do not tumble dry.

FEET HEIGHT OPTIONS

Available upon request, 10,5 cm high feet, with surcharge; 4 cm higher than the standard feet.

HINWEISE ZUR REINIGUNG DER BEZÜGE

Aufgrund der besonderen Anfertigung der Bezüge wird für alle Indoor-Stoffe der Kollektion und jede Art von Kundenstoff (auch wenn mit Wasser waschbar) ausschließlich eine extra-sanfte Trockenreinigung mit geringer mechanischer Einwirkung empfohlen. Nicht in den Trockner geben.

OPTION HÖHE DER FÜSSE

Auf Anfrage hin ist, mit Aufpreis, die 10,5 cm hohe Füße erhältlich, also 4 cm höher als die serienmäßige Ausführung.

AVERTISSEMENTS RELATIF AU NETTOYAGE DES HOUSES

Compte tenu du mode de confection particulier des housses, pour tous les tissus intérieurs de la Collection ainsi que pour toute typologie de tissu client (y compris ceux lavables à l'eau), il est conseillé de procéder exclusivement à un nettoyage à sec ultra délicat avec action mécanique réduite. Ne pas mettre au sèche-linge.

OPTION HAUTEUR DES PIEDS

Des pieds H 10,5 cm, à savoir 4 cm plus hauts que les pieds de série, sont disponibles sur demande, avec supplément.

ALTEZZA BRACCIOLI | ARMRESTS HEIGHT

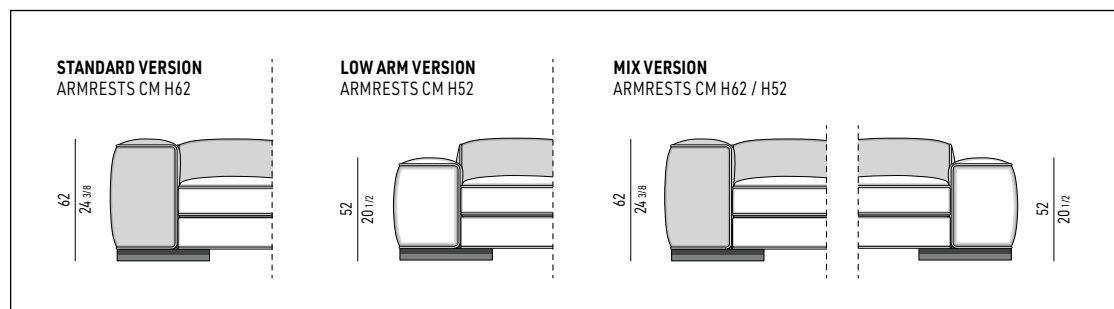

ALTEZZA PIEDINI | FEET HEIGHT

PIEDINI | FEET **CM 6,5**

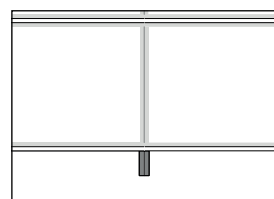

PIEDINI | FEET **CM 10,5**

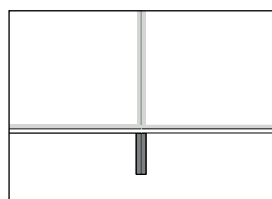

PIEDINI FEET

ALLUMINIO LUCIDO
POLISHED ALUMINIUM



CROMO
CHROME

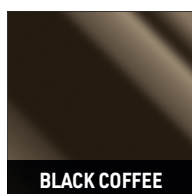

BLACK COFFEE

VERSIONE **CROMO**
CHROME VERSION

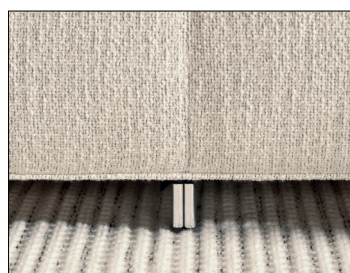

VERSIONE **BLACK COFFEE**
BLACK COFFEE VERSION



YVES

DIVANI | SOFAS

LINEAR DIVANO CM 248
LINEAR SOFA CM 248

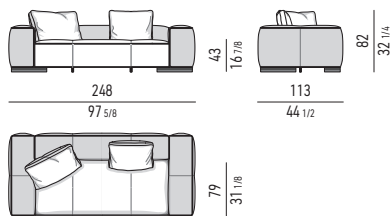

LINEAR DIVANO CM 274
LINEAR SOFA CM 274

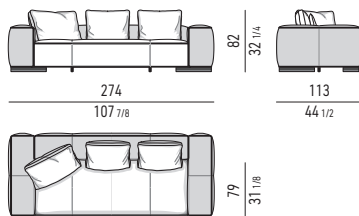

LINEAR DIVANO CM 300
LINEAR SOFA CM 300

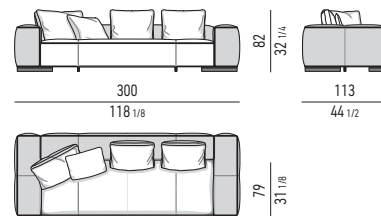

LINEAR DIVANO CM 326
LINEAR SOFA CM 326

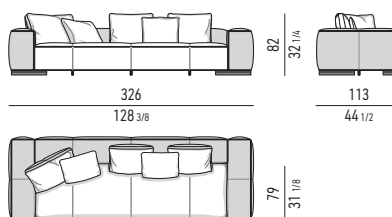

LINEAR DIVANO LOW ARM CM 248
LINEAR SOFA LOW ARM CM 248

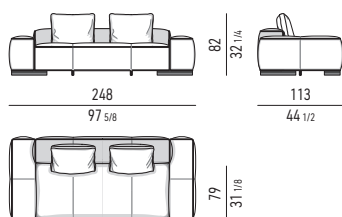

LINEAR DIVANO LOW ARM CM 274
LINEAR SOFA LOW ARM CM 274

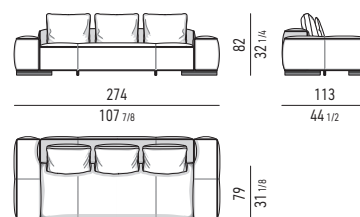

LINEAR DIVANO LOW ARM CM 300
LINEAR SOFA LOW ARM CM 300

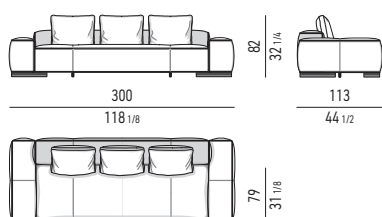

LINEAR DIVANO LOW ARM CM 326
LINEAR SOFA LOW ARM CM 326

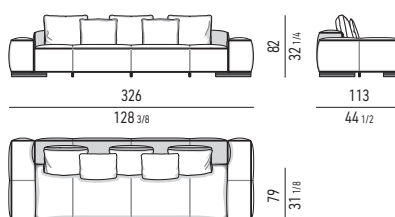

LINEAR DIVANO MIX CM 248
LINEAR SOFA MIX CM 248

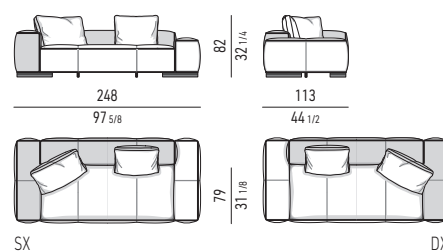

LINEAR DIVANO MIX CM 274
LINEAR SOFA MIX CM 274

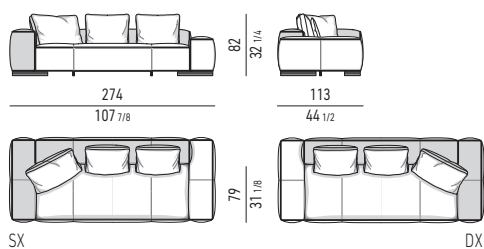

LINEAR DIVANO MIX CM 300
LINEAR SOFA MIX CM 300

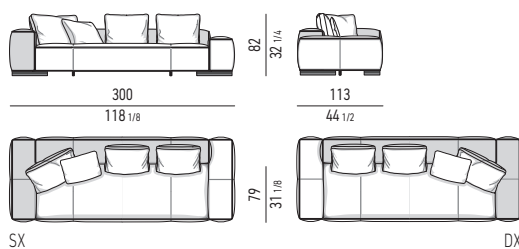

LINEAR DIVANO MIX CM 326
LINEAR SOFA MIX CM 326

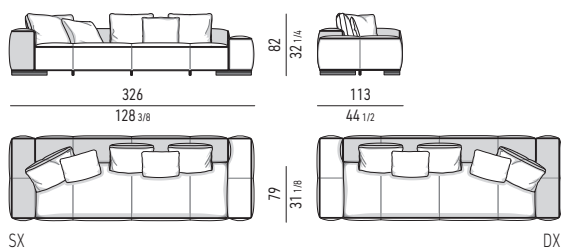

WAVE DIVANO CM 248X113
WAVE SOFA CM 248X113

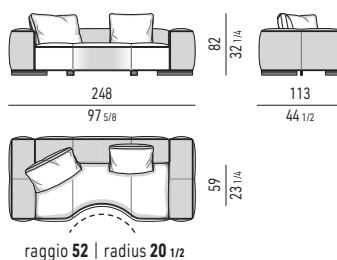

Minotti

WAVE DIVANO CM 274X113 WAVE SOFA CM 274X113

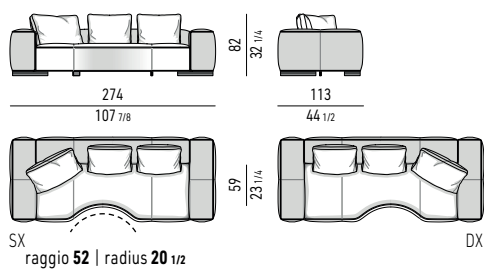

WAVE DIVANO CM 300X113 WAVE SOFA CM 300X113

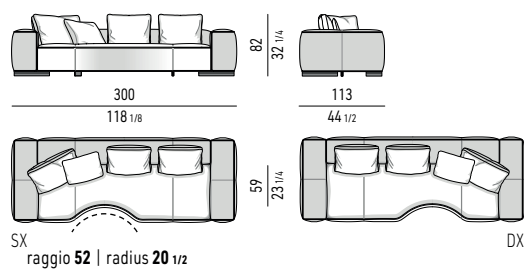

WAVE DIVANO CM 326X113 WAVE SOFA CM 326X113

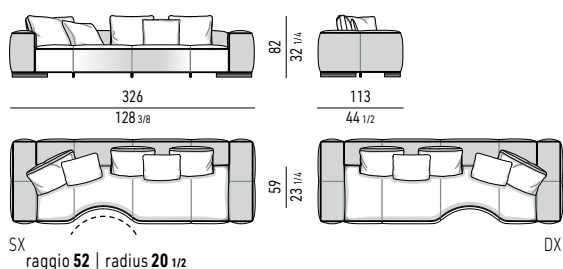

WAVE DIVANO MIX CM 274X113 WAVE SOFA MIX CM 274X113

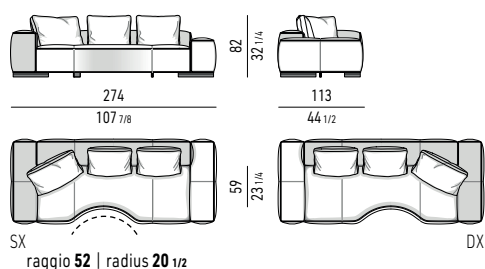

WAVE DIVANO MIX CM 300X113 - MOD. A WAVE SOFA MIX CM 300X113 - MOD. A

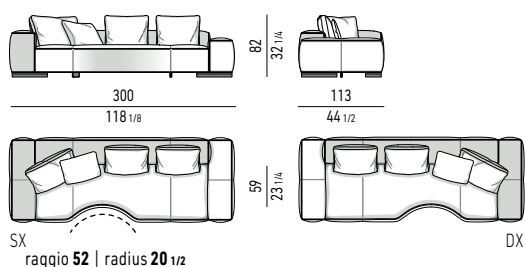

WAVE DIVANO MIX CM 300X113 - MOD. B WAVE SOFA MIX CM 300X113 - MOD. B

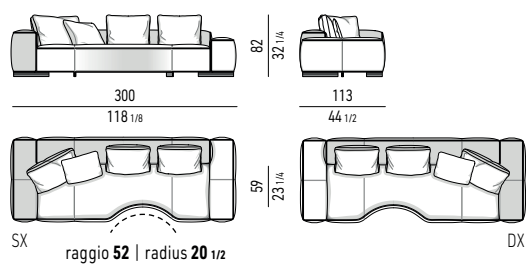

WAVE DIVANO MIX CM 326X113 - MOD. A WAVE SOFA MIX CM 326X113 - MOD. A

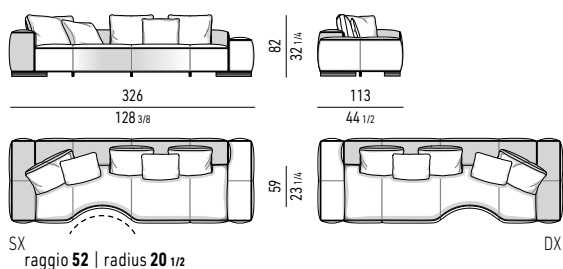

WAVE DIVANO MIX CM 326X113 - MOD. B WAVE SOFA MIX CM 326X113 - MOD. B

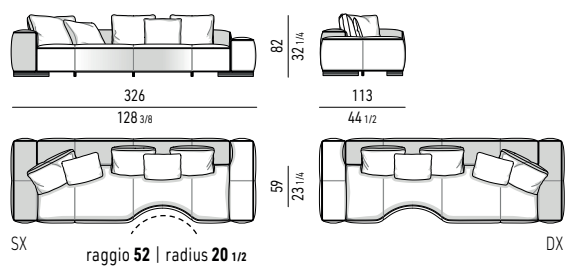

WAVE DIVANO LOW ARM CM 300X113 WAVE SOFA LOW ARM CM 300X113

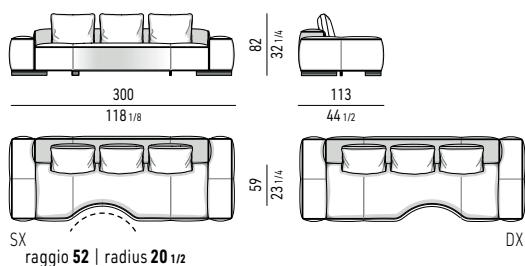

WAVE DIVANO LOW ARM CM 326X113 WAVE SOFA LOW ARM CM 326X113

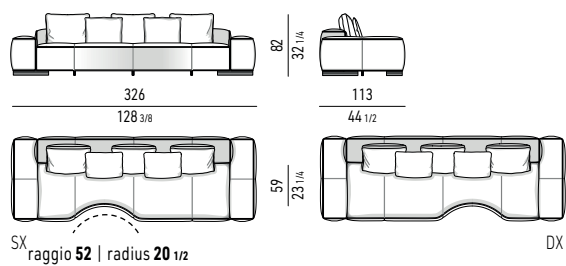

Minotti

DIVANI PROFONDITÀ CM 140 | SOFAS DEPTH CM 140

WAVE DIVANO CM 300X140 WAVE SOFA CM 300X140

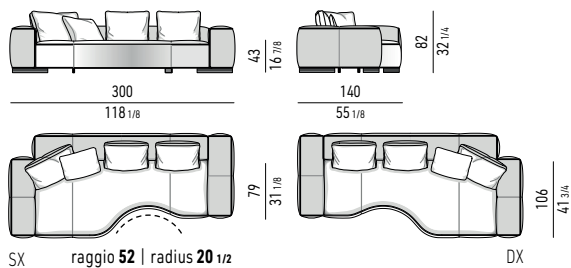

WAVE DIVANO MIX CM 300X140 WAVE SOFA MIX CM 300X140

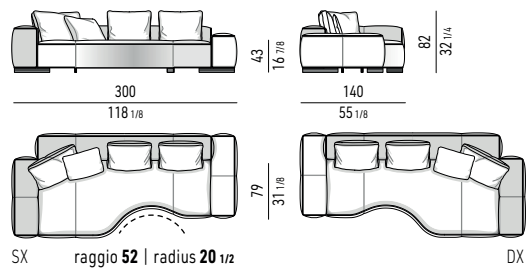

BEND DIVANO CM 300X140 BEND SOFA CM 300X140

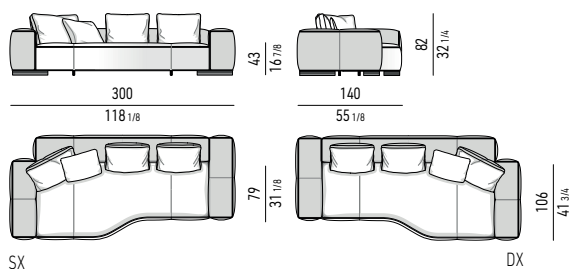

BEND DIVANO MIX CM 300X140 BEND SOFA MIX CM 300X140

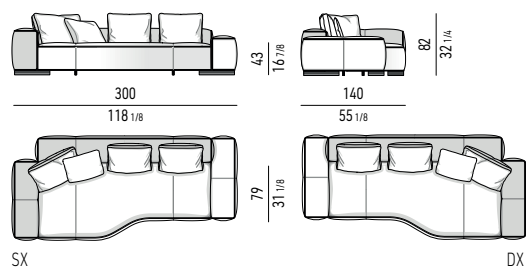

DIVANI INCLINATI | INCLINED SOFAS

INCLINED DIVANO INCLINATO CM 316X180 INCLINED INCLINED SOFA CM 316X180

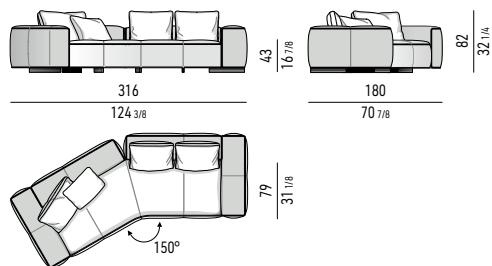

INCLINED DIVANO INCLINATO LOW ARM CM 316X180 INCLINED INCLINED SOFA LOW ARM CM 316X180

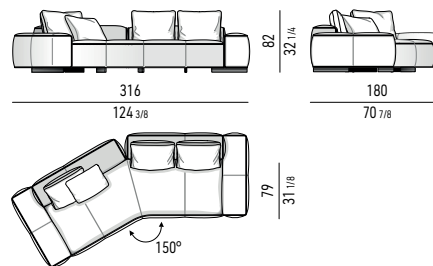

INCLINED DIVANO INCLINATO MIX CM 316X180 INCLINED INCLINED SOFA MIX CM 316X180

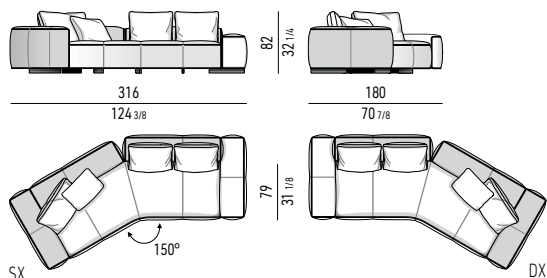

Minotti

DIVANI-DAYBED | DAYBED-SOFAS

LINEAR DIVANO-DAYBED CM 248
LINEAR DAYBED-SOFA CM 248

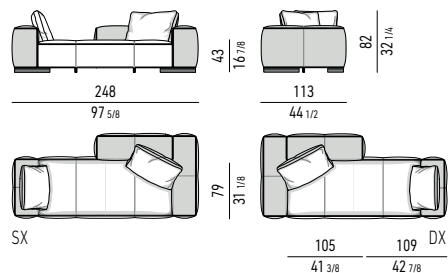

LINEAR DIVANO-DAYBED CM 274
LINEAR DAYBED-SOFA CM 274

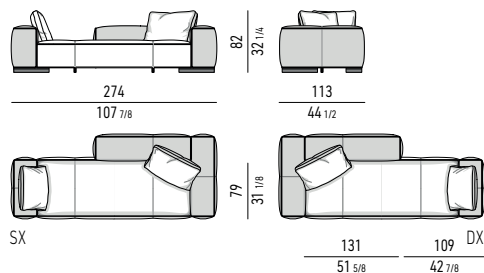

LINEAR DIVANO-DAYBED CM 300
LINEAR DAYBED-SOFA CM 300

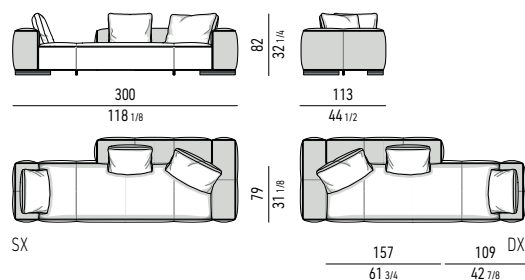

LINEAR DIVANO-DAYBED CM 326
LINEAR DAYBED-SOFA CM 326

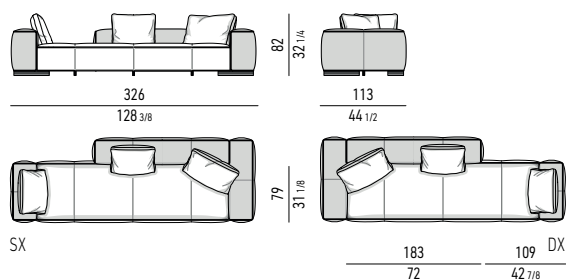

LINEAR DIVANO-DAYBED MIX CM 248
LINEAR DAYBED-SOFA MIX CM 248

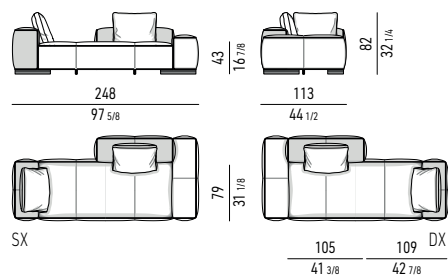

LINEAR DIVANO-DAYBED MIX CM 274
LINEAR DAYBED-SOFA MIX CM 274

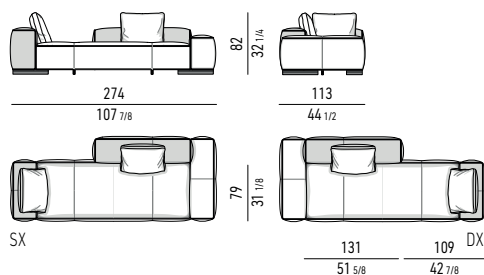

LINEAR DIVANO-DAYBED MIX CM 300
LINEAR DAYBED-SOFA MIX CM 300

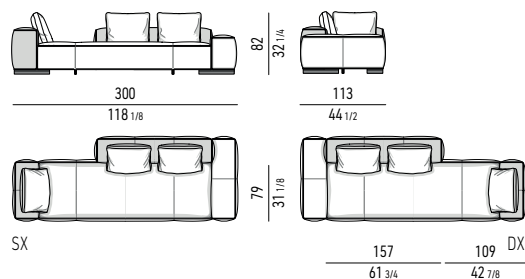

LINEAR DIVANO-DAYBED MIX CM 326
LINEAR DAYBED-SOFA MIX CM 326

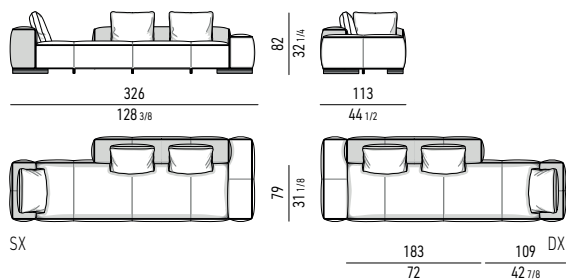

ELEMENTI TERMINALI | ELEMENTS WITH 1 ARMREST

LINEAR ELEMENTO TERMINALE CM 165
LINEAR ELEMENT WITH 1 ARMREST CM 165

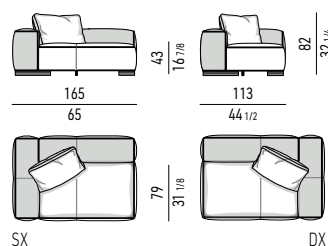

LINEAR ELEMENTO TERMINALE CM 191
LINEAR ELEMENT WITH 1 ARMREST CM 191

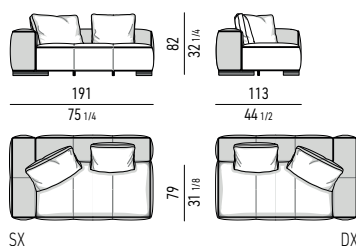

LINEAR ELEMENTO TERMINALE CM 217
LINEAR ELEMENT WITH 1 ARMREST CM 217

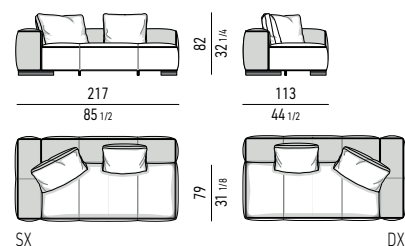

LINEAR ELEMENTO TERMINALE CM 243
LINEAR ELEMENT WITH 1 ARMREST CM 243

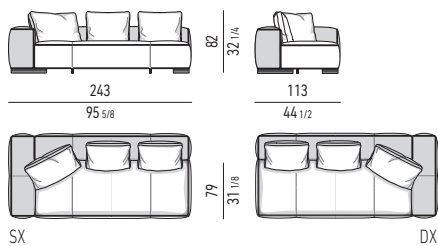

LINEAR ELEMENTO TERMINALE CM 269
LINEAR ELEMENT WITH 1 ARMREST CM 269

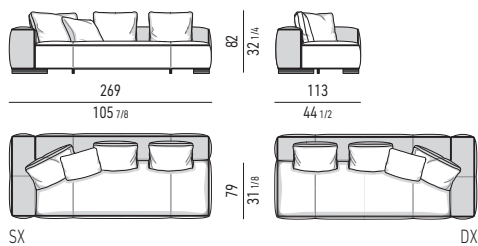

LINEAR ELEMENTO TERMINALE CM 295
LINEAR ELEMENT WITH 1 ARMREST CM 295

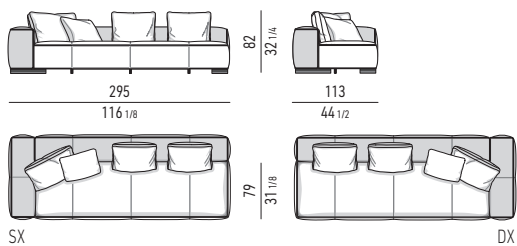

LINEAR ELEMENTO TERMINALE LOW ARM CM 165
LINEAR ELEMENT WITH 1 ARMREST LOW ARM CM 165

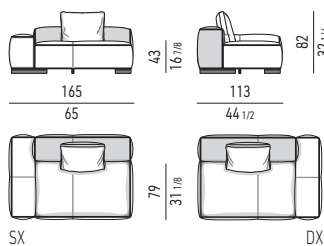

LINEAR ELEMENTO TERMINALE LOW ARM CM 191
LINEAR ELEMENT WITH 1 ARMREST LOW ARM CM 191

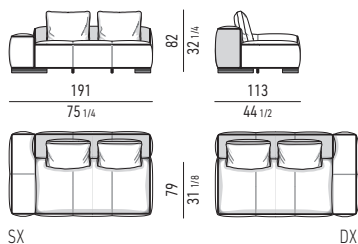

LINEAR ELEMENTO TERMINALE LOW ARM CM 217
LINEAR ELEMENT WITH 1 ARMREST LOW ARM CM 217

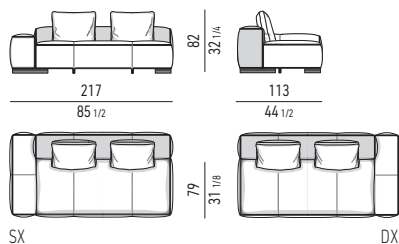

LINEAR ELEMENTO TERMINALE LOW ARM CM 243
LINEAR ELEMENT WITH 1 ARMREST LOW ARM CM 243

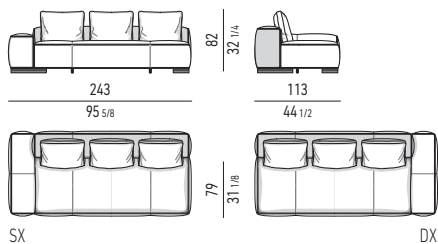

LINEAR ELEMENTO TERMINALE LOW ARM CM 269
LINEAR ELEMENT WITH 1 ARMREST LOW ARM CM 269

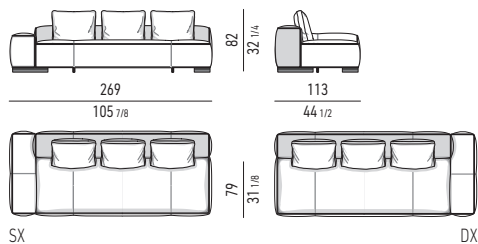

LINEAR ELEMENTO TERMINALE LOW ARM CM 295
LINEAR ELEMENT WITH 1 ARMREST LOW ARM CM 295

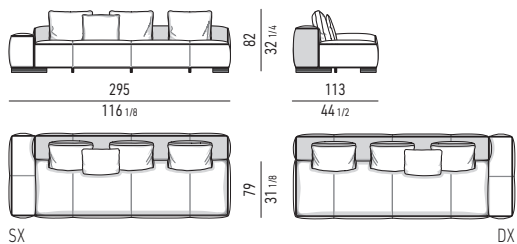

WAVE ELEMENTO TERMINALE CM 217X113
WAVE ELEMENT WITH 1 ARMREST CM 217X113

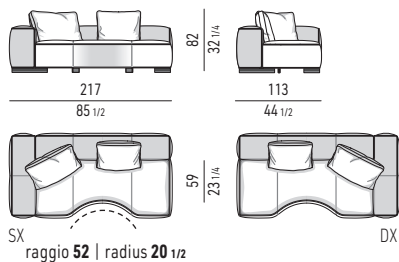

Minotti

WAVE ELEMENTO TERMINALE CM 243X113 - MOD. A
WAVE ELEMENT WITH 1 ARMREST CM 243X113 - MOD. A

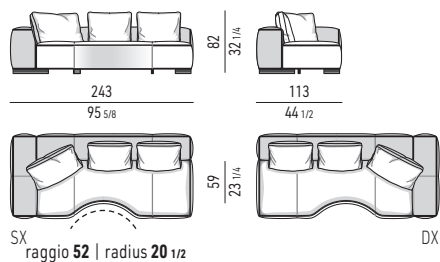

WAVE ELEMENTO TERMINALE CM 243X113 - MOD. B
WAVE ELEMENT WITH 1 ARMREST CM 243X113 - MOD. B

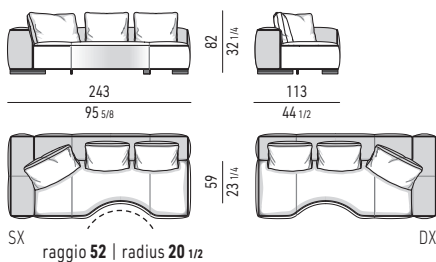

WAVE ELEMENTO TERMINALE CM 269X113 - MOD. A
WAVE ELEMENT WITH 1 ARMREST CM 269X113 - MOD. A

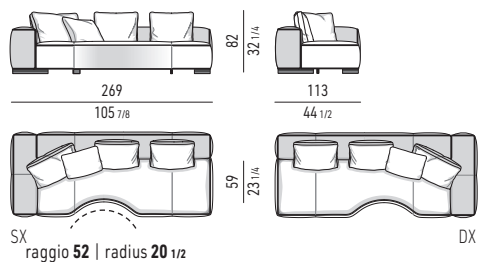

WAVE ELEMENTO TERMINALE CM 269X113 - MOD. B
WAVE ELEMENT WITH 1 ARMREST CM 269X113 - MOD. B

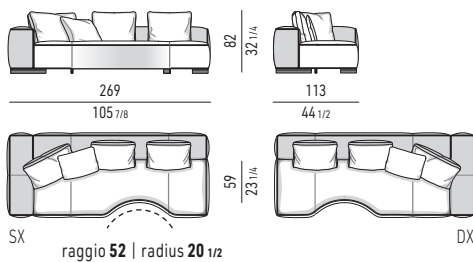

WAVE ELEMENTO TERMINALE CM 295X113 - MOD. A
WAVE ELEMENT WITH 1 ARMREST CM 295X113 - MOD. A

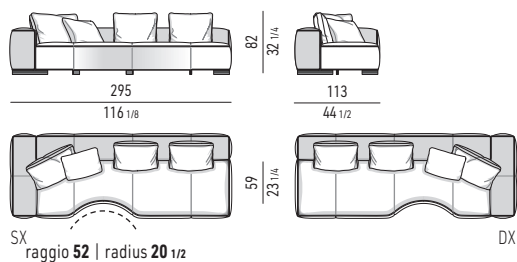

WAVE ELEMENTO TERMINALE CM 295X113 - MOD. B
WAVE ELEMENT WITH 1 ARMREST CM 295X113 - MOD. B

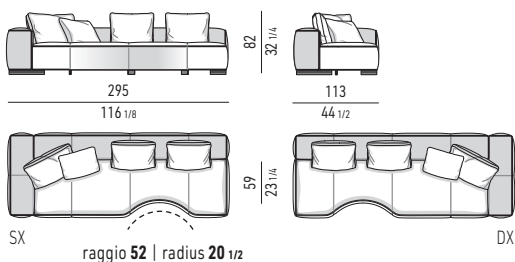

WAVE ELEMENTO TERMINALE LOW ARM CM 243X113 - MOD. A
WAVE ELEMENT WITH 1 ARMREST LOW ARM CM 243X113 - MOD. A

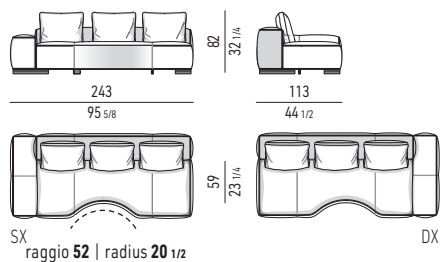

WAVE ELEMENTO TERMINALE LOW ARM CM 243X113 - MOD. B
WAVE ELEMENT WITH 1 ARMREST LOW ARM CM 243X113 - MOD. B

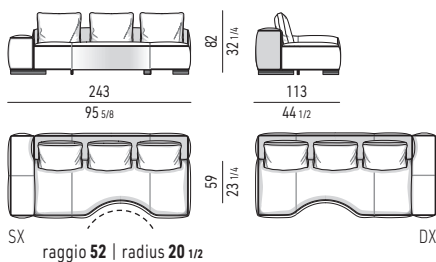

WAVE ELEMENTO TERMINALE LOW ARM CM 269X113 - MOD. A
WAVE ELEMENT WITH 1 ARMREST LOW ARM CM 269X113 - MOD. A

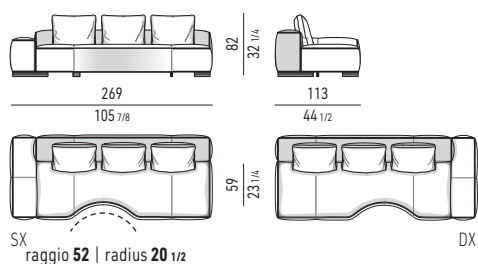

WAVE ELEMENTO TERMINALE LOW ARM CM 269X113 - MOD. B
WAVE ELEMENT WITH 1 ARMREST LOW ARM CM 269X113 - MOD. B

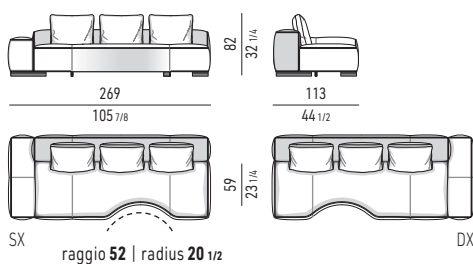

Minotti

WAVE ELEMENTO TERMINALE LOW ARM CM 295X113 - MOD. A
WAVE ELEMENT WITH 1 ARMREST LOW ARM CM 295X113 - MOD. A

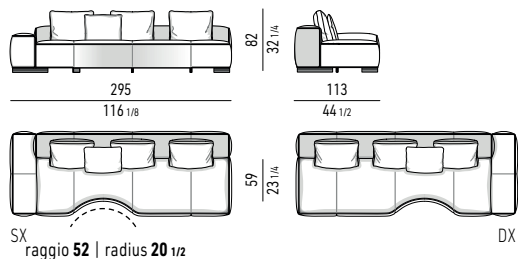

WAVE ELEMENTO TERMINALE LOW ARM CM 295X113 - MOD. B
WAVE ELEMENT WITH 1 ARMREST LOW ARM CM 295X113 - MOD. B

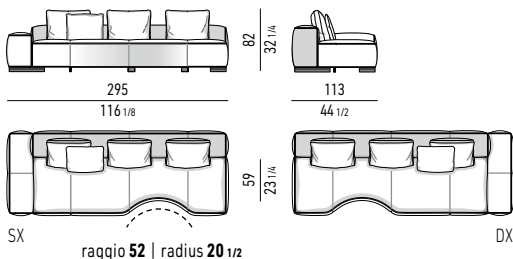

WAVE ELEMENTO TERMINALE CM 217X140
WAVE ELEMENT WITH 1 ARMREST CM 217X140

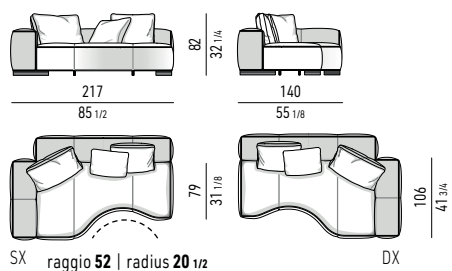

WAVE ELEMENTO TERMINALE CM 269X140
WAVE ELEMENT WITH 1 ARMREST CM 269X140

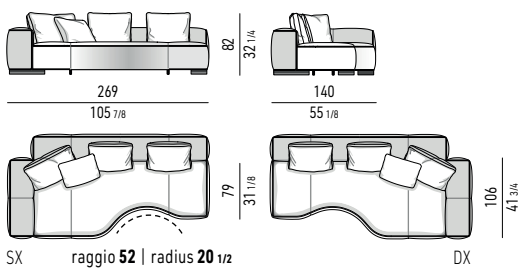

BEND ELEMENTO TERMINALE CM 217X140
BEND ELEMENT WITH 1 ARMREST CM 217X140

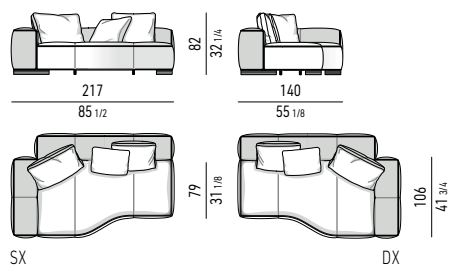

BEND ELEMENTO TERMINALE CM 269X140
BEND ELEMENT WITH 1 ARMREST CM 269X140

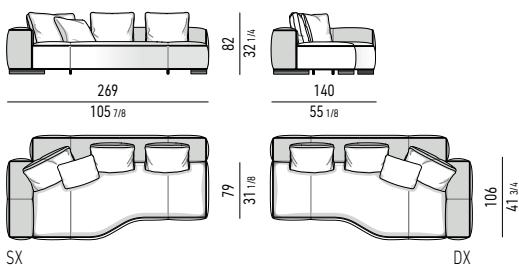

LINEAR ELEMENTO TERMINALE PENISOLA CM 217X113
LINEAR OPEN-END ELEMENT WITH ARMREST CM 217X113

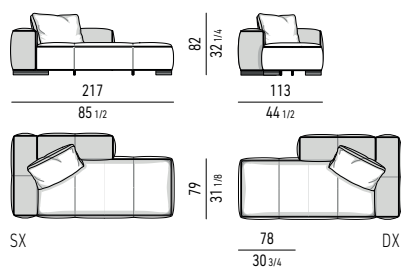

LINEAR ELEMENTO TERMINALE PENISOLA CM 243X113
LINEAR OPEN-END ELEMENT WITH ARMREST CM 243X113

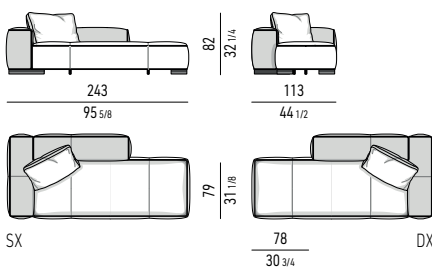

LINEAR ELEMENTO TERMINALE PENISOLA CM 269X113
LINEAR OPEN-END ELEMENT WITH ARMREST CM 269X113

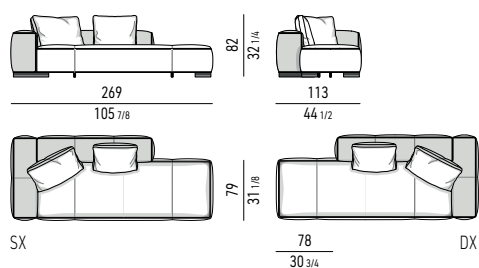

LINEAR ELEMENTO TERMINALE PENISOLA CM 295X113
LINEAR OPEN-END ELEMENT WITH ARMREST CM 295X113

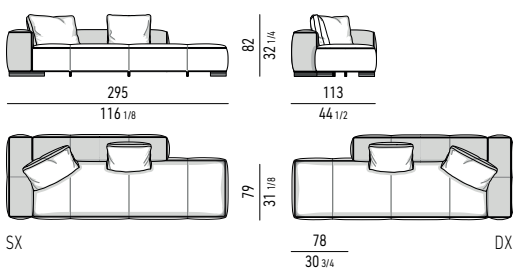

Minotti

LINEAR ELEMENTO TERMINALE PENISOLA LOW ARM CM 217X113
LINEAR OPEN-END ELEMENT WITH ARMREST LOW ARM CM 217X113

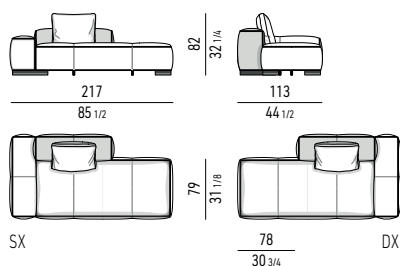

LINEAR ELEMENTO TERMINALE PENISOLA LOW ARM CM 243X113
LINEAR OPEN-END ELEMENT WITH ARMREST LOW ARM CM 243X113

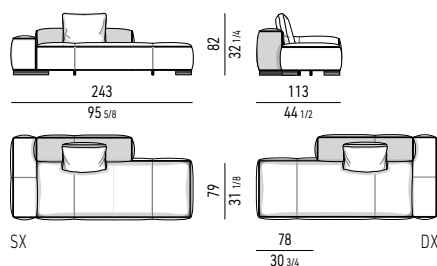

LINEAR ELEMENTO TERMINALE PENISOLA LOW ARM CM 269X113
LINEAR OPEN-END ELEMENT WITH ARMREST LOW ARM CM 269X113

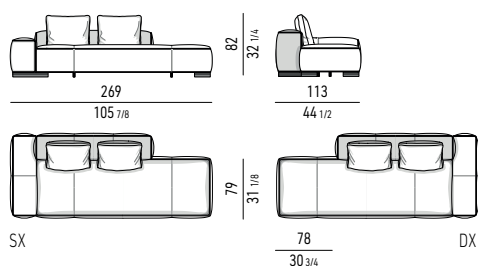

LINEAR ELEMENTO TERMINALE PENISOLA LOW ARM CM 295X113
LINEAR OPEN-END ELEMENT WITH ARMREST LOW ARM CM 295X113

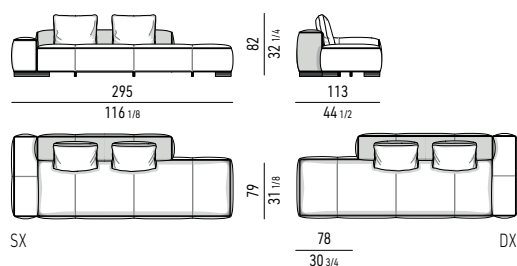

ELEMENTI TERMINALI PROFONDITÀ CM 140 | ELEMENTS WITH 1 ARMREST DEPTH CM 140

BEND ELEMENTO TERMINALE PENISOLA CM 217X140
BEND OPEN-END ELEMENT WITH 1 ARMREST CM 217X140

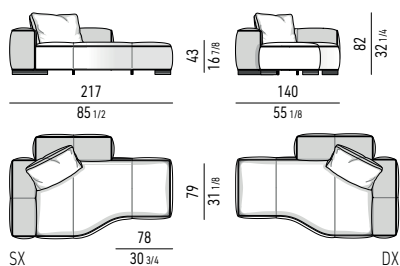

BEND ELEMENTO TERMINALE PENISOLA CM 269X140
BEND OPEN-END ELEMENT WITH 1 ARMREST CM 269X140

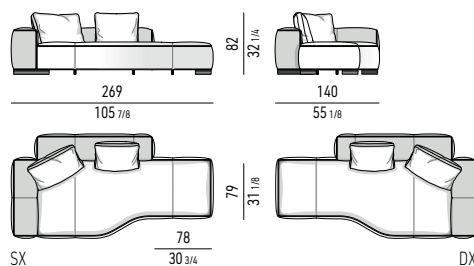

WAVE ELEMENTO TERMINALE PENISOLA CM 269X140
WAVE OPEN-END ELEMENT WITH 1 ARMREST CM 269X140

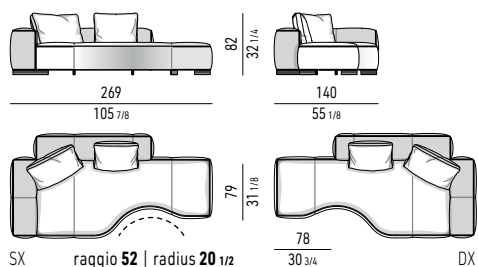

ELEMENTI TERMINALI INCLINATI | INCLINED ELEMENTS WITH ARMREST

WAVE ELEMENTO TERMINALE INCLINATO CM 303X113
WAVE INCLINED ELEMENT WITH 1 ARMREST CM 303X113

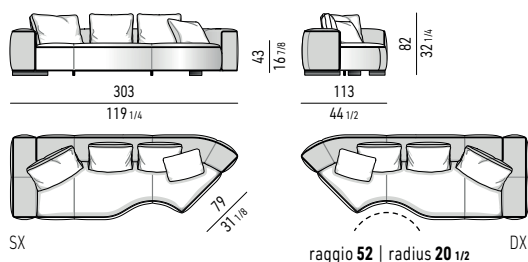

WAVE ELEMENTO TERMINALE INCLINATO CM 328X113
WAVE INCLINED ELEMENT WITH 1 ARMREST CM 328X113

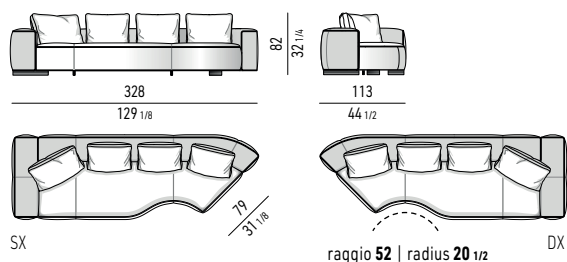

WAVE ELEMENTO TERMINALE INCLINATO LOW ARM CM 303X113
WAVE INCLINED ELEMENT WITH 1 ARMREST LOW ARM CM 303X113

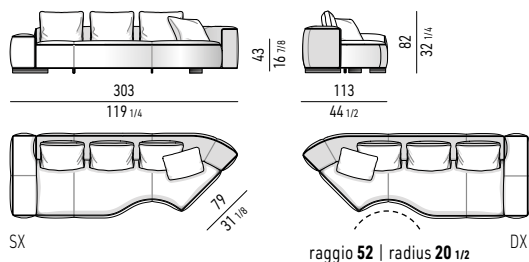

WAVE ELEMENTO TERMINALE INCLINATO LOW ARM CM 328X113
WAVE INCLINED ELEMENT WITH 1 ARMREST LOW ARM CM 328X113

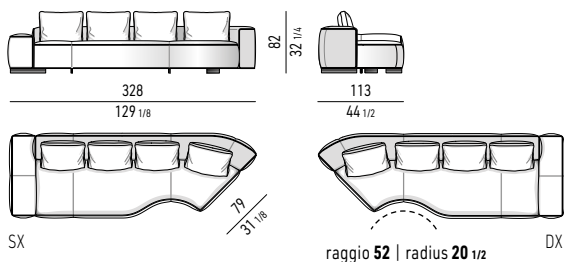

WAVE ELEMENTO TERMINALE INCLINATO CM 282X113
WAVE INCLINED ELEMENT WITH 1 ARMREST CM 282X113

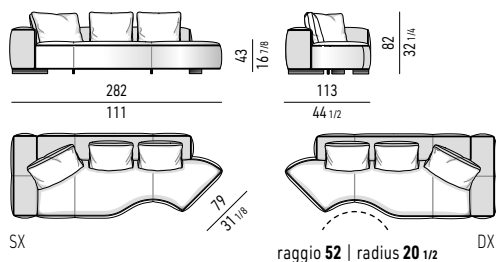

WAVE ELEMENTO TERMINALE INCLINATO CM 307X113
WAVE INCLINED ELEMENT WITH 1 ARMREST CM 307X113

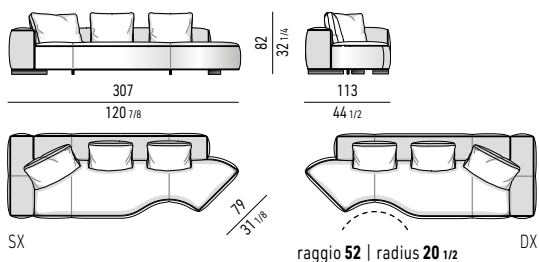

WAVE ELEMENTO TERMINALE INCLINATO LOW ARM CM 282X113
WAVE INCLINED ELEMENT WITH 1 ARMREST LOW ARM CM 282X113

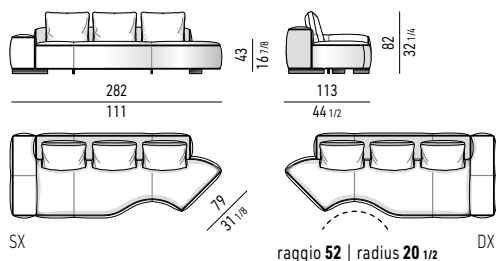

WAVE ELEMENTO TERMINALE INCLINATO LOW ARM CM 307X113
WAVE INCLINED ELEMENT WITH 1 ARMREST LOW ARM CM 307X113

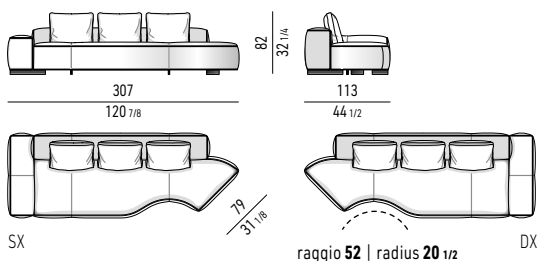

WAVE ELEMENTO TERMINALE INCLINATO PENISOLA CM 282X113
WAVE INCLINED OPEN-END ELEMENT WITH ARMREST CM 282X113

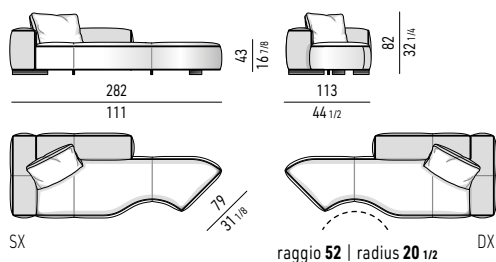

WAVE ELEMENTO TERMINALE INCLINATO PENISOLA CM 307X113
WAVE INCLINED OPEN-END ELEMENT WITH ARMREST CM 307X113

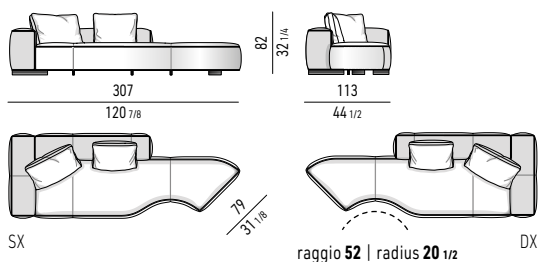

WAVE ELEMENTO TERMINALE INCLINATO PENISOLA LOW ARM CM 282X113
WAVE INCLINED OPEN-END ELEMENT WITH ARMREST LOW ARM CM 282X113

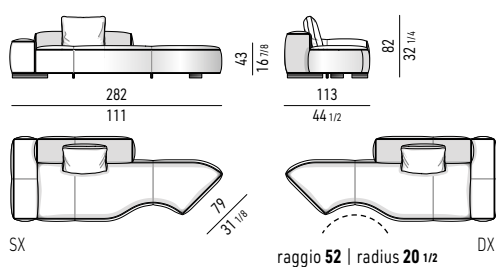

WAVE ELEMENTO TERMINALE INCLINATO PENISOLA LOW ARM CM 307X113
WAVE INCLINED OPEN-END ELEMENT WITH ARMREST LOW ARM CM 307X113

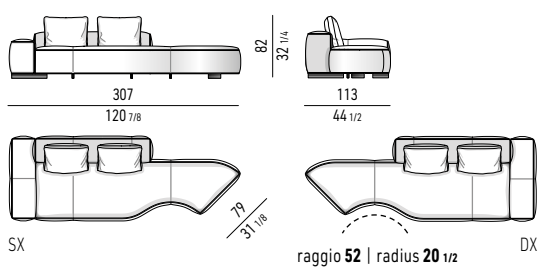

Minotti

INCLINED ELEMENTO TERMINALE INCLINATO CM 236X166
INCLINED INCLINED ELEMENT WITH ARMREST CM 236X166

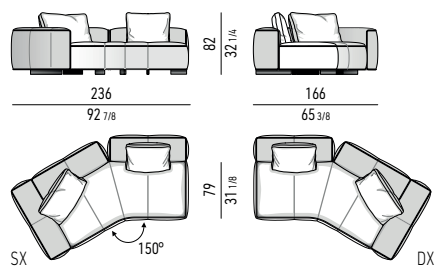

INCLINED ELEMENTO TERMINALE INCLINATO CM 285X180
INCLINED INCLINED ELEMENT WITH ARMREST CM 285X180

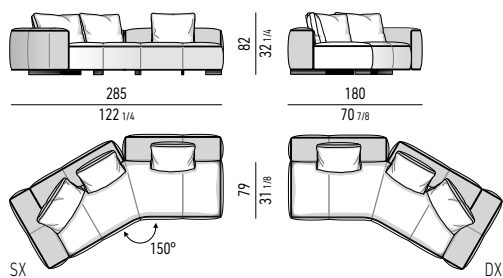

INCLINED ELEMENTO TERMINALE INCLINATO LOW ARM CM 236X166
INCLINED INCLINED ELEMENT WITH ARMREST LOW ARM CM 236X166

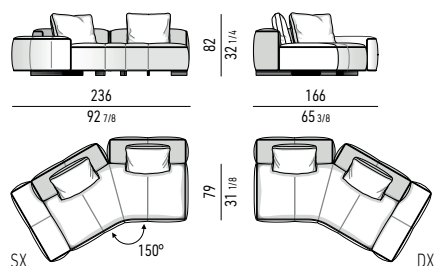

INCLINED ELEMENTO TERMINALE INCLINATO LOW ARM CM 285X180
INCLINED INCLINED ELEMENT WITH ARMREST LOW ARM CM 285X180

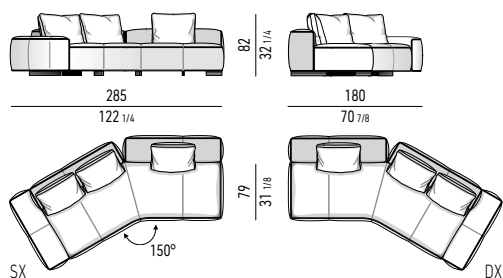

ELEMENTI DAYBED | DAYBED ELEMENTS

LINEAR ELEMENTO DAYBED CM 217
LINEAR DAYBED ELEMENT CM 217

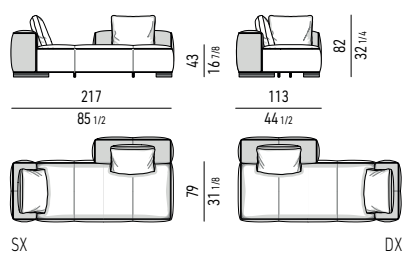

LINEAR ELEMENTO DAYBED CM 243
LINEAR DAYBED ELEMENT CM 243

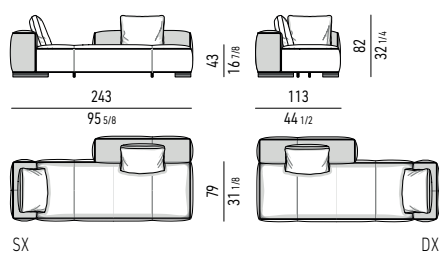

LINEAR ELEMENTO DAYBED CM 269
LINEAR DAYBED ELEMENT CM 269

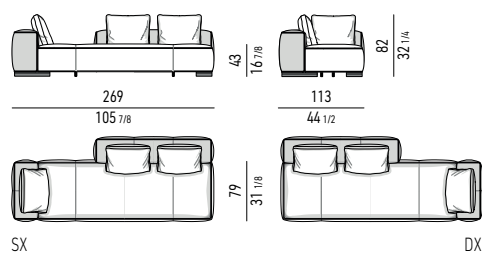

LINEAR ELEMENTO DAYBED CM 295
LINEAR DAYBED ELEMENT CM 295

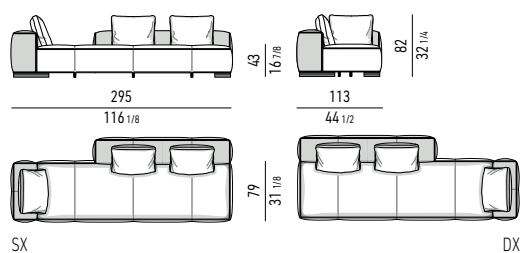

ELEMENTI CENTRALI | CENTRAL ELEMENTS

LINEAR ELEMENTO CENTRALE CM 134
LINEAR CENTRAL ELEMENT CM 134

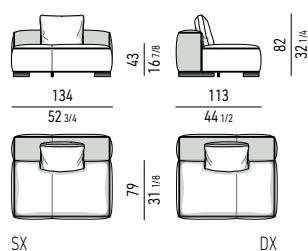

LINEAR ELEMENTO CENTRALE CM 160
LINEAR CENTRAL ELEMENT CM 160

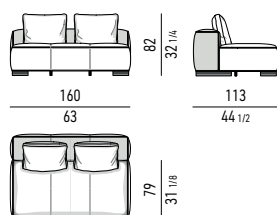

LINEAR ELEMENTO CENTRALE CM 186
LINEAR CENTRAL ELEMENT CM 186

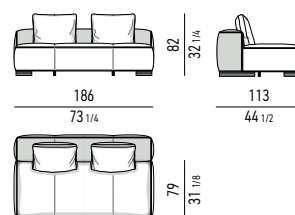

Minotti

LINEAR ELEMENTO CENTRALE CM 212
LINEAR CENTRAL ELEMENT CM 212

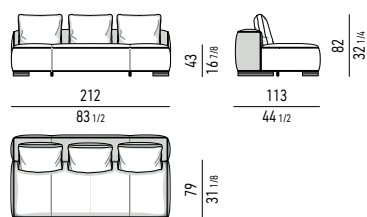

LINEAR ELEMENTO CENTRALE CM 238
LINEAR CENTRAL ELEMENT CM 238

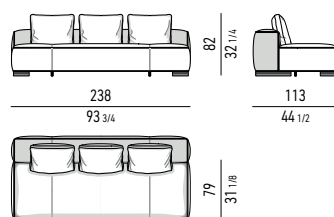

LINEAR ELEMENTO CENTRALE CM 264
LINEAR CENTRAL ELEMENT CM 264

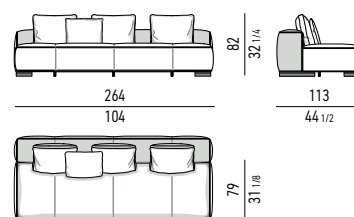

WAVE ELEMENTO CENTRALE CM 186X113
WAVE CENTRAL ELEMENT CM 186X113

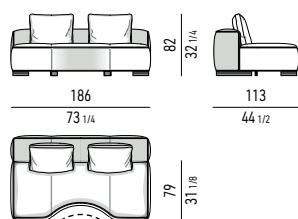

raggio 52 | radius 20 1/2

WAVE ELEMENTO CENTRALE CM 212X113
WAVE CENTRAL ELEMENT CM 212X113

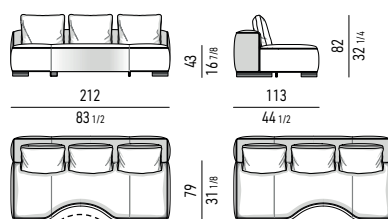

SX raggio 52 | radius 20 1/2

DX

WAVE ELEMENTO CENTRALE CM 238X113
WAVE CENTRAL ELEMENT CM 238X113

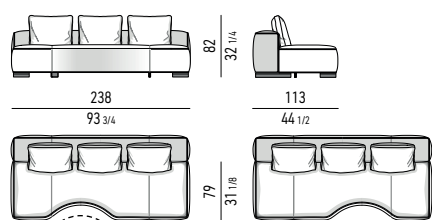

SX raggio 52 | radius 20 1/2

DX

WAVE ELEMENTO CENTRALE CM 264X113
WAVE CENTRAL ELEMENT CM 264X113

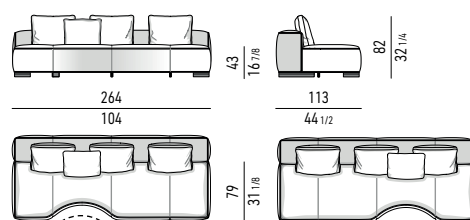

SX raggio 52 | radius 20 1/2

DX

ELEMENTI CENTRALI PROFONDITA CM 140 | CENTRAL ELEMENTS DEPTH CM 140

WAVE ELEMENTO CENTRALE CM 186X140
WAVE CENTRAL ELEMENT CM 186X140

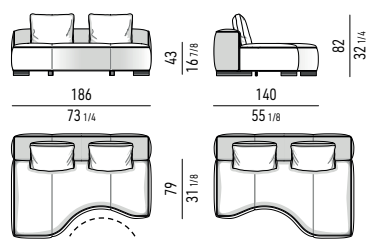

raggio 52 | radius 20 1/2

SX

DX

WAVE ELEMENTO CENTRALE CM 238X140
WAVE CENTRAL ELEMENT CM 238X140

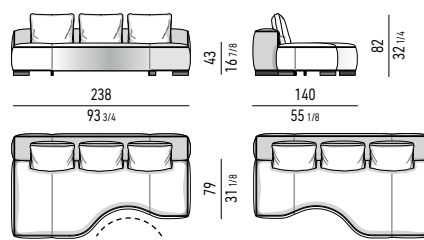

SX raggio 52 | radius 20 1/2

DX

BEND ELEMENTO CENTRALE CM 186X140
BEND CENTRAL ELEMENT CM 186X140

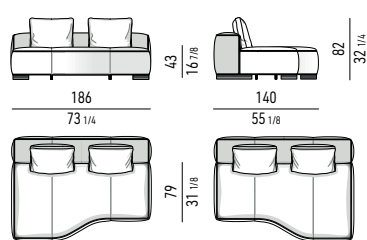

SX

DX

BEND ELEMENTO CENTRALE CM 238X140
BEND CENTRAL ELEMENT CM 238X140

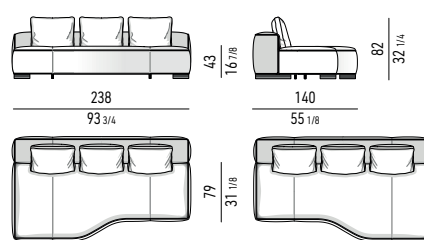

SX

DX

Minotti

ELEMENTI PENISOLA | OPEN-END ELEMENTS

LINEAR ELEMENTO PENISOLA CM 186
LINEAR OPEN-END ELEMENT CM 186

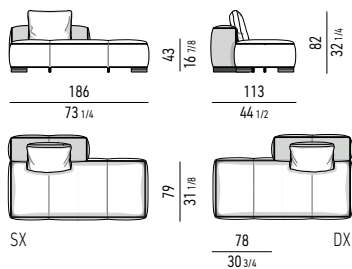

LINEAR ELEMENTO PENISOLA CM 212
LINEAR OPEN-END ELEMENT CM 212

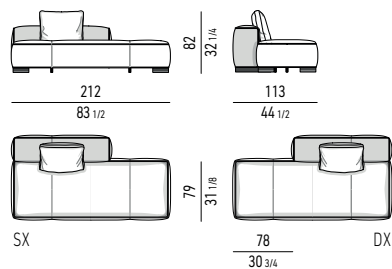

LINEAR ELEMENTO PENISOLA CM 238
LINEAR OPEN-END ELEMENT CM 238

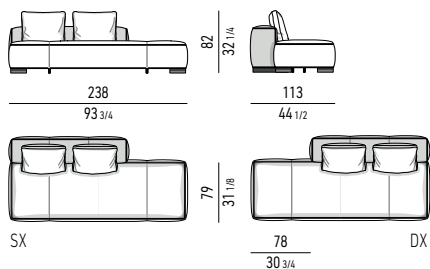

LINEAR ELEMENTO PENISOLA CM 264
LINEAR OPEN-END ELEMENT CM 264

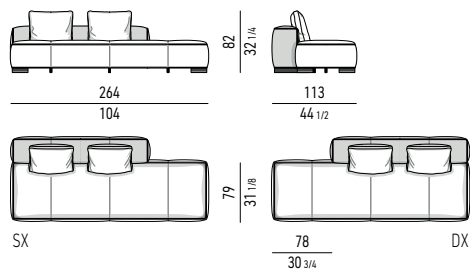

BEND ELEMENTO PENISOLA CM 186X140
BEND OPEN-END ELEMENT CM 186X140

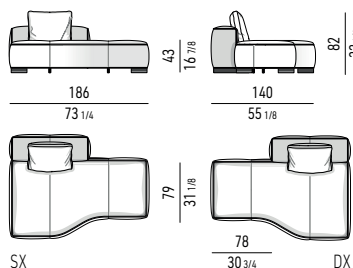

BEND ELEMENTO PENISOLA CM 238X140
BEND OPEN-END ELEMENT CM 238X140

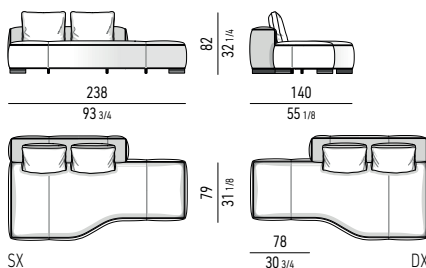

WAVE ELEMENTO PENISOLA CM 238X140
WAVE OPEN-END ELEMENT CM 238X140

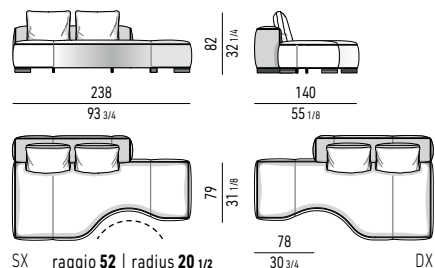

ELEMENTI CENTRALI INCLINATI | INCLINED CENTRAL ELEMENTS

WAVE ELEMENTO CENTRALE INCLINATO CM 272X113
WAVE INCLINED CENTRAL ELEMENT CM 272X113

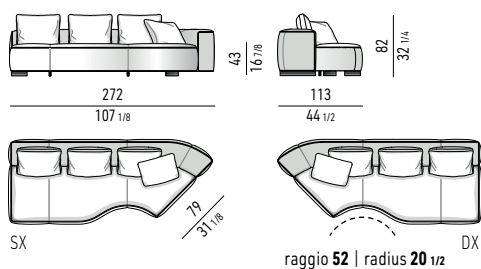

WAVE ELEMENTO CENTRALE INCLINATO CM 297X113
WAVE INCLINED CENTRAL ELEMENT CM 297X113

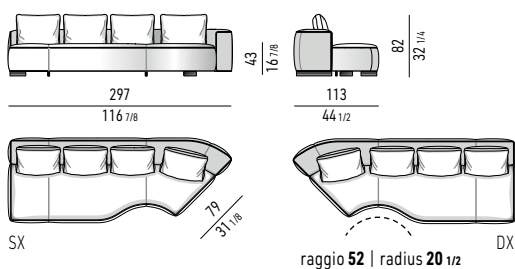

WAVE ELEMENTO CENTRALE INCLINATO CM 251X113
WAVE INCLINED CENTRAL ELEMENT CM 251X113

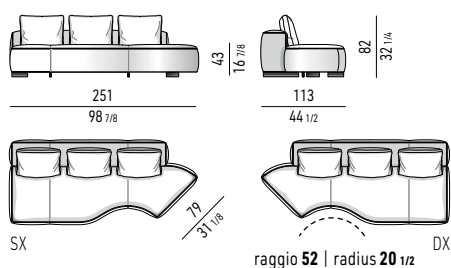

WAVE ELEMENTO CENTRALE INCLINATO CM 276X113
WAVE INCLINED CENTRAL ELEMENT CM 276X113

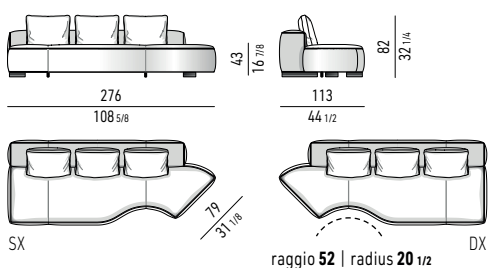

Minotti

INCLINED ELEMENTO CENTRALE INCLINATO CM 209X151 INCLINED INCLINED CENTRAL ELEMENT CM 209X151

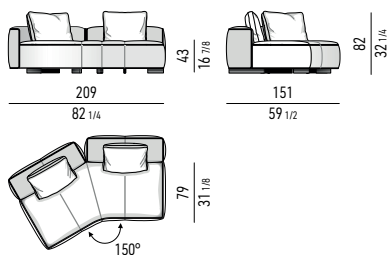

INCLINED ELEMENTO CENTRALE INCLINATO CM 258X165 INCLINED INCLINED CENTRAL ELEMENT CM 258X165

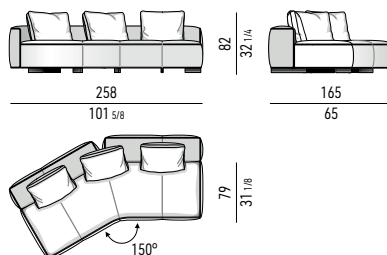

ELEMENTI PENISOLA INCLINATI | INCLINED OPEN-END ELEMENTS

WAVE ELEMENTO PENISOLA INCLINATO CM 251X113 WAVE INCLINED OPEN-END ELEMENT CM 251X113

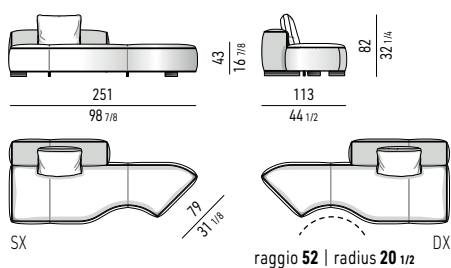

WAVE ELEMENTO PENISOLA INCLINATO CM 276X113 WAVE INCLINED OPEN-END ELEMENT CM 276X113

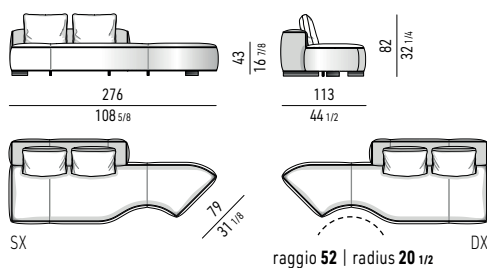

COUCH | COUCHES

LINEAR COUCH CM 134X191 LINEAR COUCH CM 134X191

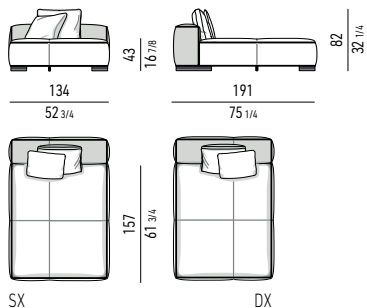

LINEAR COUCH CM 160X191 LINEAR COUCH CM 160X191

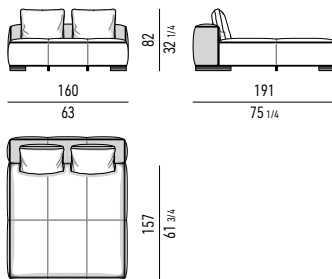

WAVE COUCH CM 160X165 WAVE COUCH CM 160X165

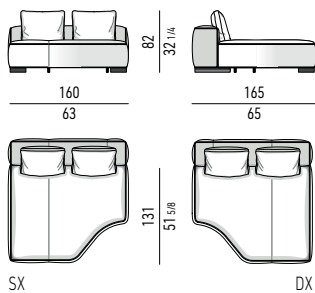

WAVE COUCH CM 160X191 WAVE COUCH CM 160X191

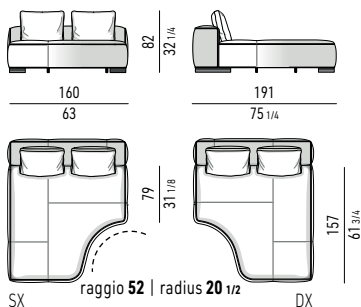

CHAISE-LONGUES

LINEAR CHAISE-LONGUE CM 165X191
LINEAR CHAISE-LONGUE CM 165X191

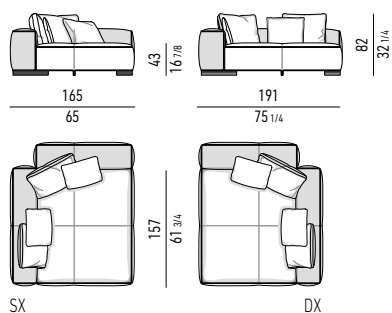

LINEAR CHAISE-LONGUE CM 191X191
LINEAR CHAISE-LONGUE CM 191X191

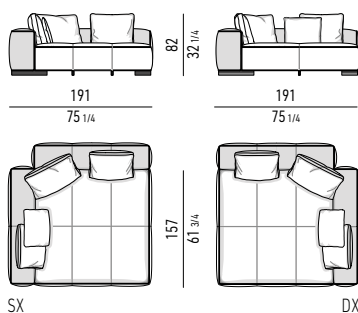

WAVE CHAISE-LONGUE CM 191X165
WAVE CHAISE-LONGUE CM 191X165

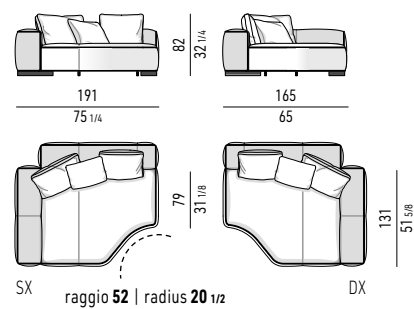

WAVE CHAISE-LONGUE CM 191X191 - BRACCIOLO CM 108
WAVE CHAISE-LONGUE CM 191X191 - ARMREST CM 108

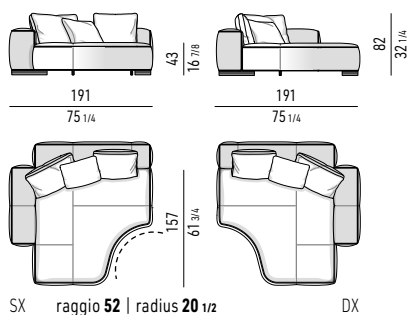

WAVE CHAISE-LONGUE CM 191X191 - BRACCIOLO CM 160
WAVE CHAISE-LONGUE CM 191X191 - ARMREST CM 160

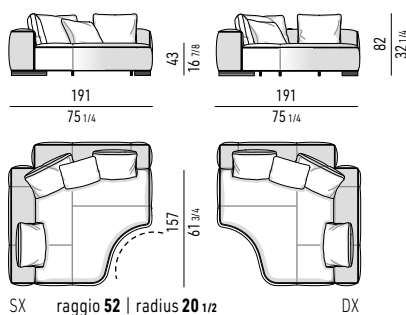

BEND CHAISE-LONGUE CM 265X213
BEND CHAISE-LONGUE CM 265X213

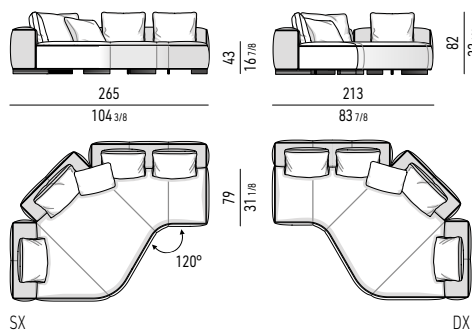

INCLINED CHAISE-LONGUE INCLINATA CM 236X196
INCLINED INCLINED CHAISE-LONGUE CM 236X196

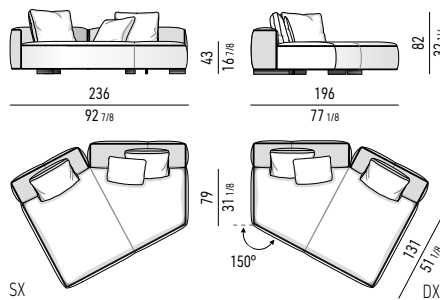

INCLINED CHAISE-LONGUE INCLINATA CM 249X211
INCLINED INCLINED CHAISE-LONGUE CM 249X211

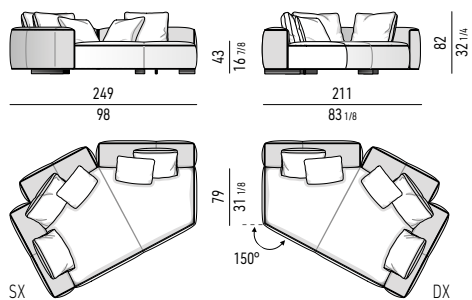

INCLINED CHAISE-LONGUE INCLINATA CM 287X196
INCLINED INCLINED CHAISE-LONGUE CM 287X196

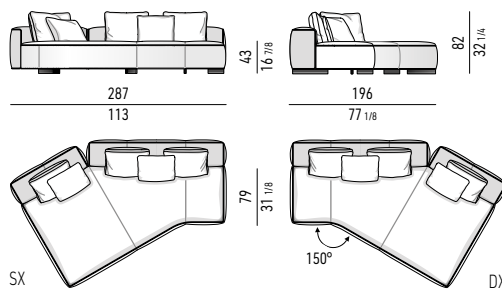

Minotti

INCLINED CHAISE-LONGUE INCLINATA CM 300X211 INCLINED INCLINED CHAISE-LONGUE CM 300X211

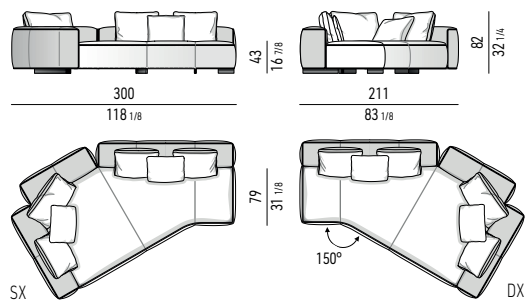

INCLINED CHAISE-LONGUE INCLINATA OPEN CM 287X196 INCLINED INCLINED CHAISE-LONGUE OPEN CM 287X196

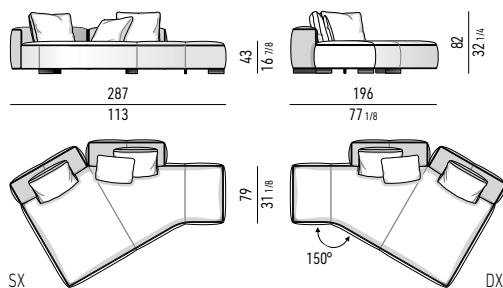

INCLINED CHAISE-LONGUE INCLINATA OPEN CM 300X211 INCLINED INCLINED CHAISE-LONGUE OPEN CM 300X211

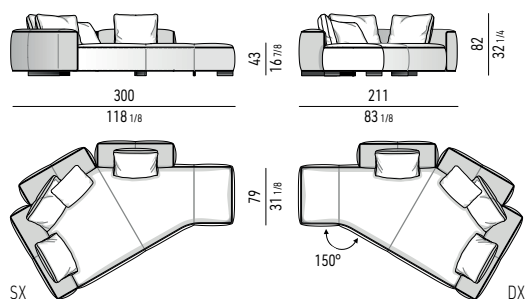

POUF | OTTOMANS

POUF Ø CM 64 OTTOMAN Ø CM 64

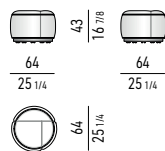

POUF Ø CM 84 OTTOMAN Ø CM 84

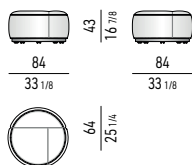

POUF Ø CM 104 OTTOMAN Ø CM 104

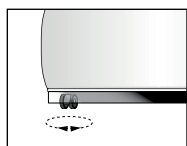
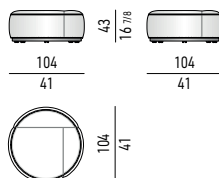

APPOGGIO A TERRA TRAMITE 5 RUOTE CON MOVIMENTO GIREVOLE A 360°.
RESTS ON 5 CASTERS WITH 360° SWIVEL

LINEAR POUF CM 108X56 LINEAR OTTOMAN CM 108X56

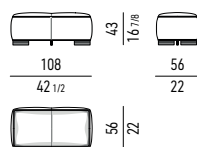

LINEAR POUF CM 134X56 LINEAR OTTOMAN CM 134X56

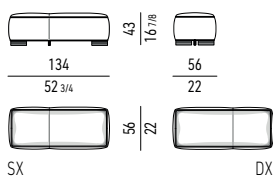

LINEAR POUF CM 160X56 LINEAR OTTOMAN CM 160X56

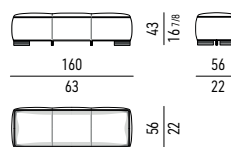

LINEAR POUF CM 134X82 LINEAR OTTOMAN CM 134X82

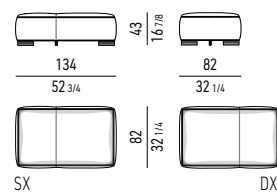

LINEAR POUF CM 160X82
LINEAR OTTOMAN CM 160X82

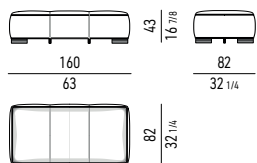

LINEAR POUF CM 82X82
LINEAR OTTOMAN CM 82X82

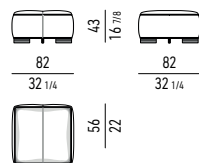

LINEAR POUF CM 113X113
LINEAR OTTOMAN CM 113X113

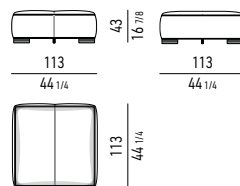

LINEAR POUF CM 134X134
LINEAR OTTOMAN CM 134X134

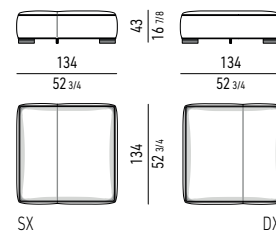

ALTEZZA BASE | BASE HEIGHT

VERSIONE | VERSION **STANDARD**

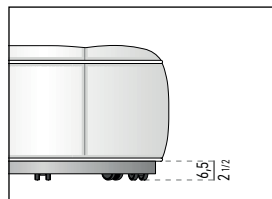

VERSIONE | VERSION **HIGH**

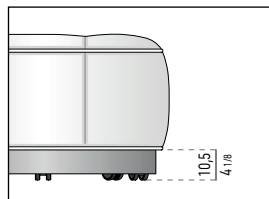

CUSCINI OPTIONAL | OPTIONAL CUSHIONS

CUSCINO SCHIENALE OPTIONAL CM 75X65
OPTIONAL BACKREST CUSHION CM 75X65

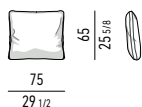

CUSCINO SCHIENALE OPTIONAL CM 60X55
OPTIONAL BACKREST CUSHION CM 60X55

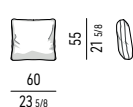

CUSCINO OPTIONAL CM 50X50
OPTIONAL CUSHION CM 50X50

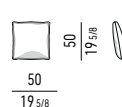

YVES SUITE

DIVANI | SOFAS

SUITE DIVANO CM 248
SUITE SOFA CM 248

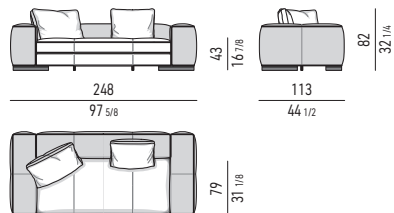

SUITE DIVANO CM 274
SUITE SOFA CM 274

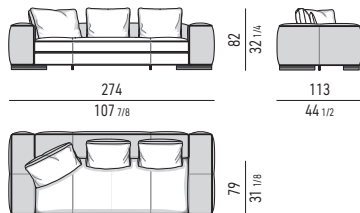

SUITE DIVANO CM 300
SUITE SOFA CM 300

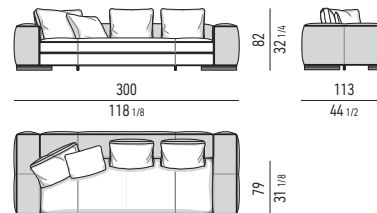

SUITE DIVANO CM 326
SUITE SOFA CM 326

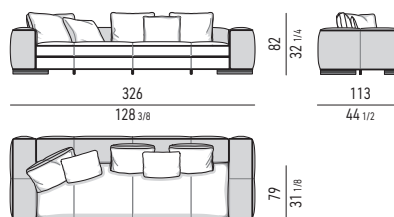

SUITE DIVANO LOW ARM CM 248
SUITE SOFA LOW ARM CM 248

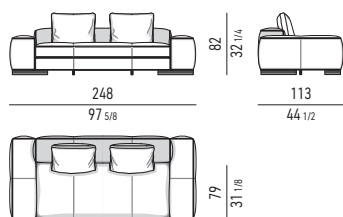

SUITE DIVANO LOW ARM CM 274
SUITE SOFA LOW ARM CM 274

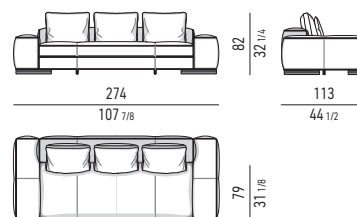

SUITE DIVANO LOW ARM CM 300
SUITE SOFA LOW ARM CM 300

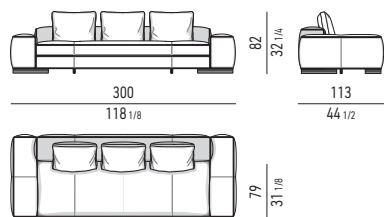

SUITE DIVANO LOW ARM CM 326
SUITE SOFA LOW ARM CM 326

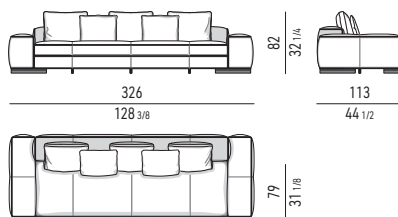

SUITE DIVANO MIX CM 248
SUITE SOFA MIX CM 248

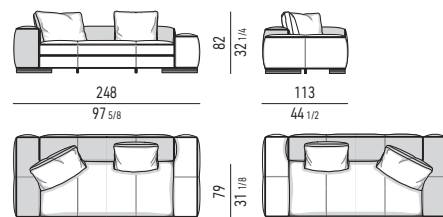

SX

DX

SUITE DIVANO MIX CM 274
SUITE SOFA MIX CM 274

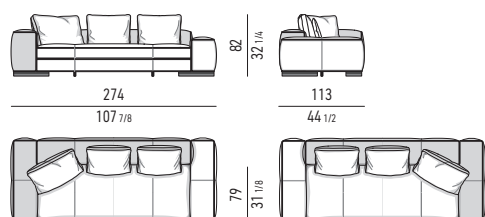

SX

DX

SUITE DIVANO MIX CM 300
SUITE SOFA MIX CM 300

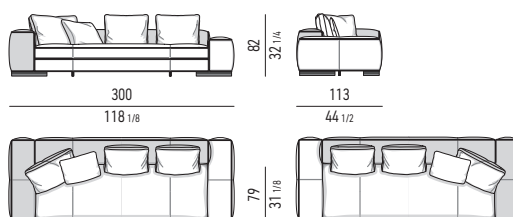

SX

DX

SUITE DIVANO MIX CM 326
SUITE SOFA MIX CM 326

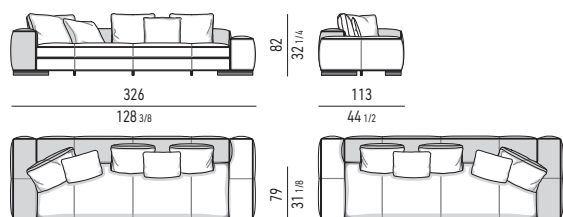

SX

DX

Minotti

DIVANI-DAYBED | DAYBED-SOFAS

SUITE DIVANO-DAYBED CM 248
SUITE DAYBED-SOFA CM 248

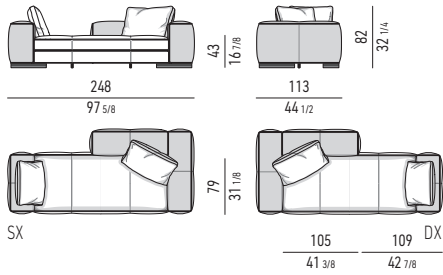

SUITE DIVANO-DAYBED CM 274
SUITE DAYBED-SOFA CM 274

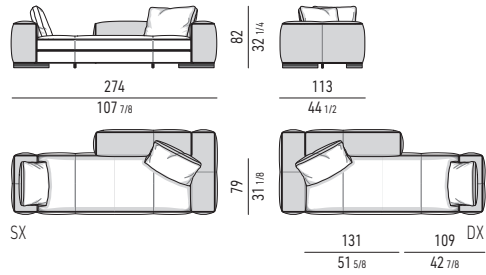

SUITE DIVANO-DAYBED CM 300
SUITE DAYBED-SOFA CM 300

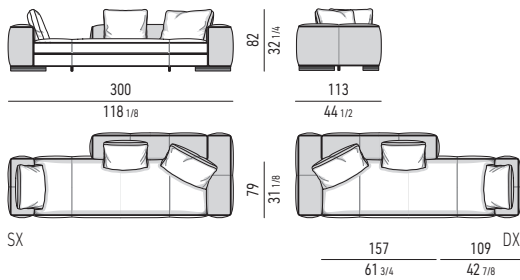

SUITE DIVANO-DAYBED CM 326
SUITE DAYBED-SOFA CM 326

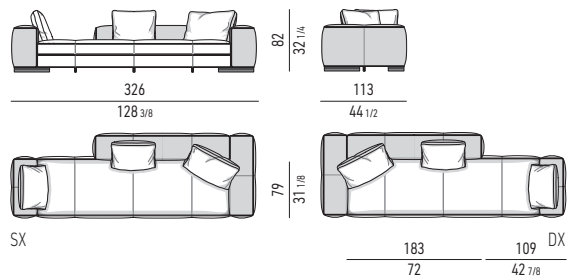

SUITE DIVANO-DAYBED MIX CM 248
SUITE DAYBED-SOFA MIX CM 248

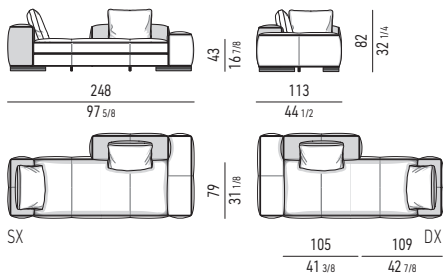

SUITE DIVANO-DAYBED MIX CM 274
SUITE DAYBED-SOFA MIX CM 274

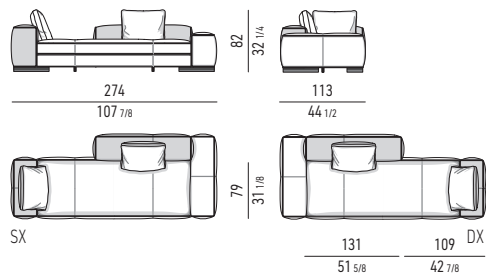

SUITE DIVANO-DAYBED MIX CM 300
SUITE DAYBED-SOFA MIX CM 300

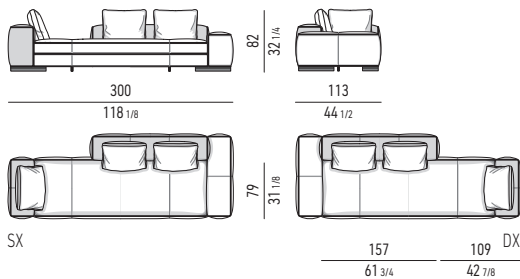

SUITE DIVANO-DAYBED MIX CM 326
SUITE DAYBED-SOFA MIX CM 326

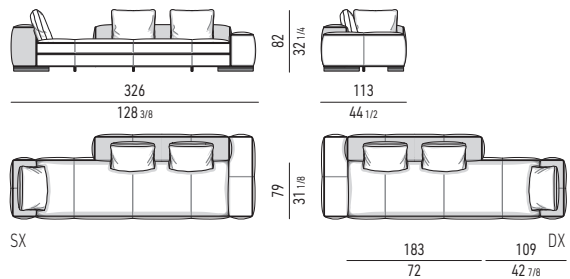

ELEMENTI TERMINALI | ELEMENTS WITH 1 ARMREST

SUITE ELEMENTO TERMINALE CM 165
SUITE ELEMENT WITH 1 ARMREST CM 165

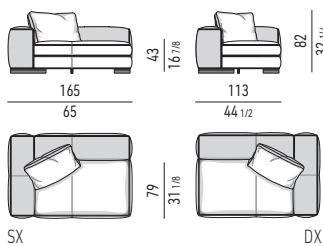

SUITE ELEMENTO TERMINALE CM 191
SUITE ELEMENT WITH 1 ARMREST CM 191

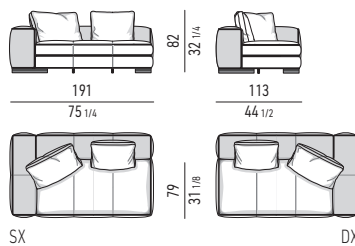

SUITE ELEMENTO TERMINALE CM 217
SUITE ELEMENT WITH 1 ARMREST CM 217

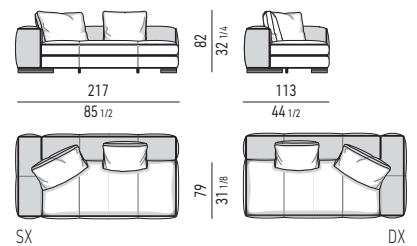

Minotti

SUITE ELEMENTO TERMINALE CM 243
SUITE ELEMENT WITH 1 ARMREST CM 243

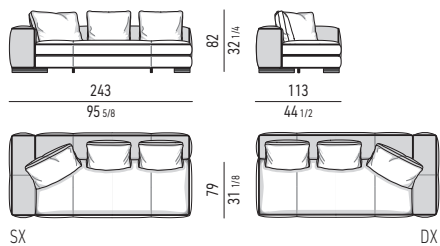

SUITE ELEMENTO TERMINALE CM 269
SUITE ELEMENT WITH 1 ARMREST CM 269

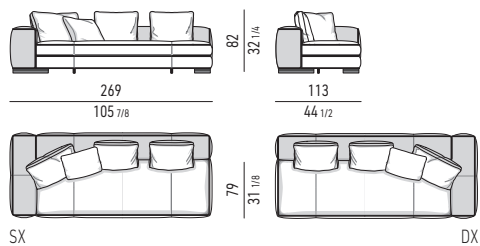

SUITE ELEMENTO TERMINALE CM 295
SUITE ELEMENT WITH 1 ARMREST CM 295

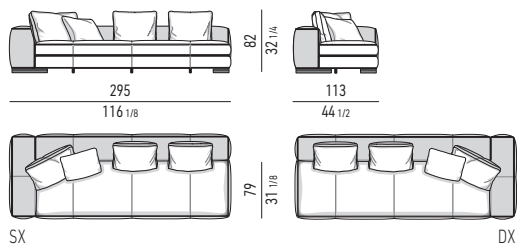

SUITE ELEMENTO TERMINALE LOW ARM CM 165
SUITE ELEMENT WITH 1 ARMREST LOW ARM CM 165

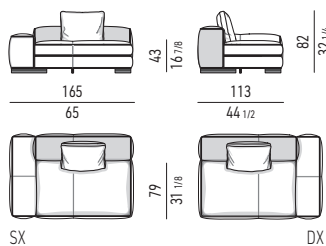

SUITE ELEMENTO TERMINALE LOW ARM CM 191
SUITE ELEMENT WITH 1 ARMREST LOW ARM CM 191

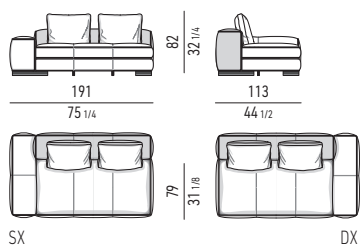

SUITE ELEMENTO TERMINALE LOW ARM CM 217
SUITE ELEMENT WITH 1 ARMREST LOW ARM CM 217

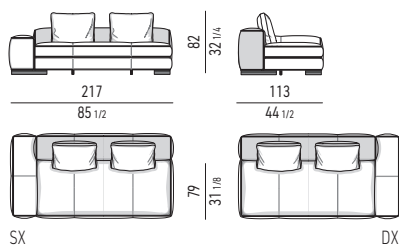

SUITE ELEMENTO TERMINALE LOW ARM CM 243
SUITE ELEMENT WITH 1 ARMREST LOW ARM CM 243

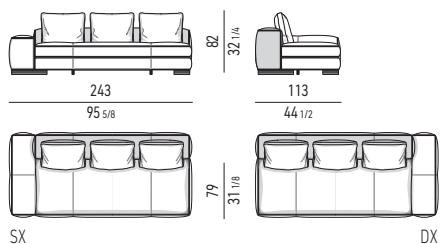

SUITE ELEMENTO TERMINALE LOW ARM CM 269
SUITE ELEMENT WITH 1 ARMREST LOW ARM CM 269

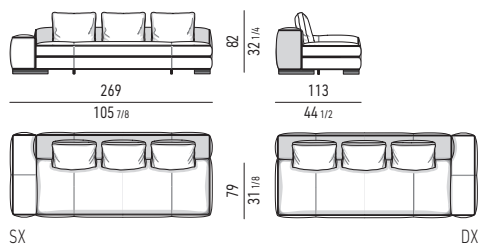

SUITE ELEMENTO TERMINALE LOW ARM CM 295
SUITE ELEMENT WITH 1 ARMREST LOW ARM CM 295

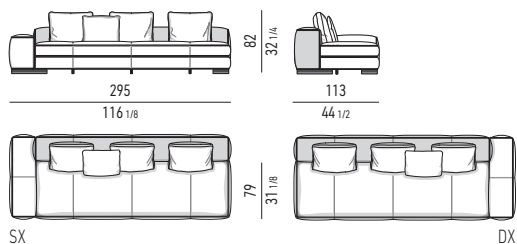

Minotti

SUITE ELEMENTO TERMINALE PENISOLA CM 217X113
SUITE OPEN-END ELEMENT WITH ARMREST CM 217X113

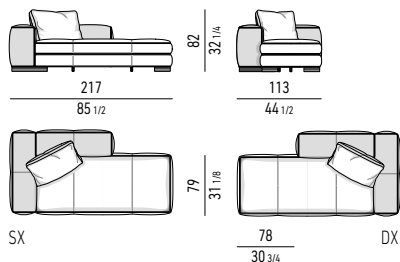

SUITE ELEMENTO TERMINALE PENISOLA CM 243X113
SUITE OPEN-END ELEMENT WITH ARMREST CM 243X113

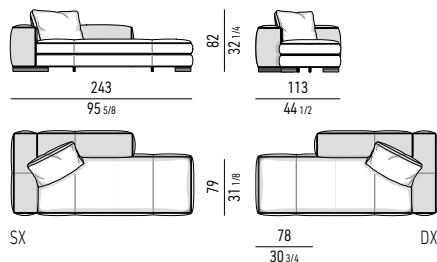

SUITE ELEMENTO TERMINALE PENISOLA CM 269X113
SUITE OPEN-END ELEMENT WITH ARMREST CM 269X113

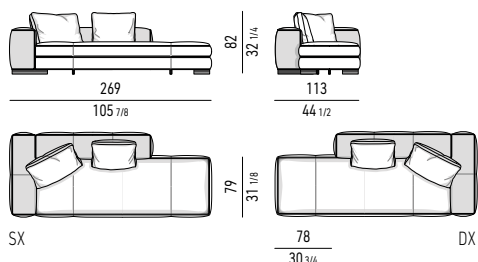

SUITE ELEMENTO TERMINALE PENISOLA CM 295X113
SUITE OPEN-END ELEMENT WITH ARMREST CM 295X113

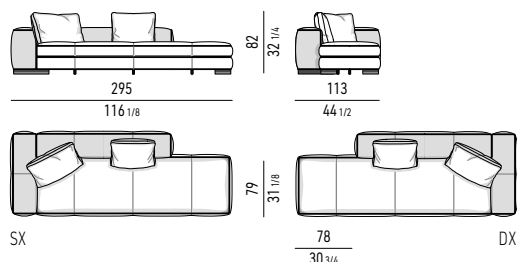

SUITE ELEMENTO TERMINALE PENISOLA LOW ARM CM 217X113
SUITE OPEN-END ELEMENT WITH ARMREST LOW ARM CM 217X113

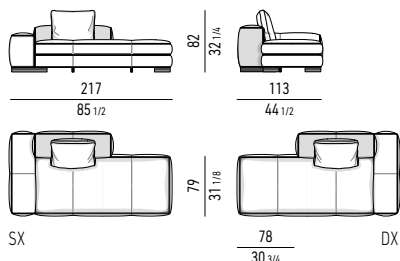

SUITE ELEMENTO TERMINALE PENISOLA LOW ARM CM 243X113
SUITE OPEN-END ELEMENT WITH ARMREST LOW ARM CM 243X113

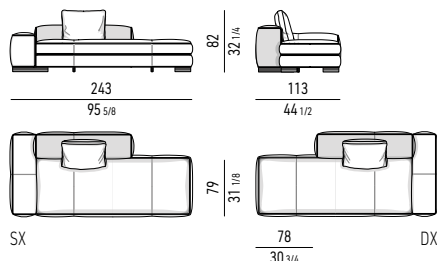

SUITE ELEMENTO TERMINALE PENISOLA LOW ARM CM 269X113
SUITE OPEN-END ELEMENT WITH ARMREST LOW ARM CM 269X113

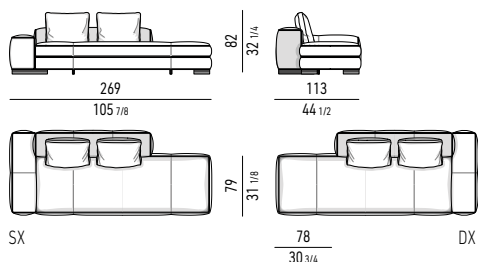

SUITE ELEMENTO TERMINALE PENISOLA LOW ARM CM 295X113
SUITE OPEN-END ELEMENT WITH ARMREST LOW ARM CM 295X113

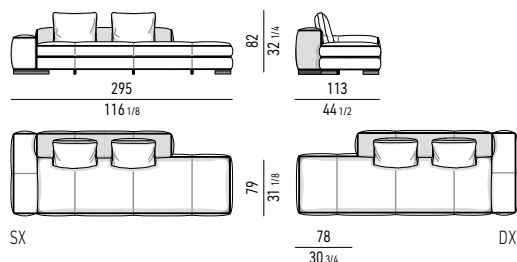

ELEMENTI DAYBED | DAYBED ELEMENTS

SUITE ELEMENTO DAYBED CM 217
SUITE DAYBED ELEMENT CM 217

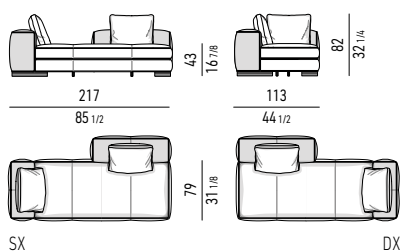

SUITE ELEMENTO DAYBED CM 243
SUITE DAYBED ELEMENT CM 243

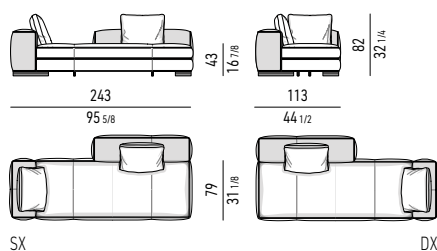

SUITE ELEMENTO DAYBED CM 269
SUITE DAYBED ELEMENT CM 269

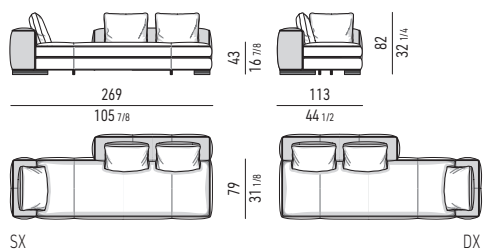

SUITE ELEMENTO DAYBED CM 295
SUITE DAYBED ELEMENT CM 295

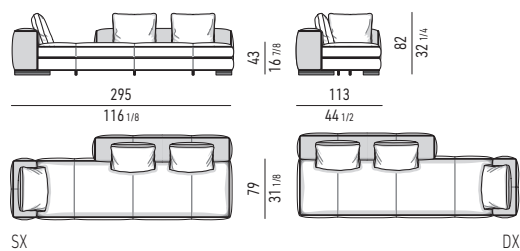

ELEMENTI CENTRALI | CENTRAL ELEMENTS

SUITE ELEMENTO CENTRALE CM 134
SUITE CENTRAL ELEMENT CM 134

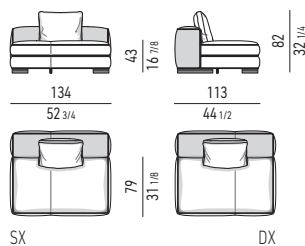

SUITE ELEMENTO CENTRALE CM 160
SUITE CENTRAL ELEMENT CM 160

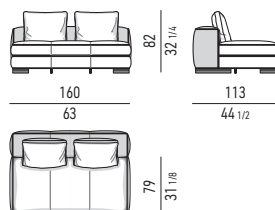

SUITE ELEMENTO CENTRALE CM 186
SUITE CENTRAL ELEMENT CM 186

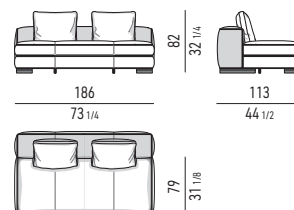

SUITE ELEMENTO CENTRALE CM 212
SUITE CENTRAL ELEMENT CM 212

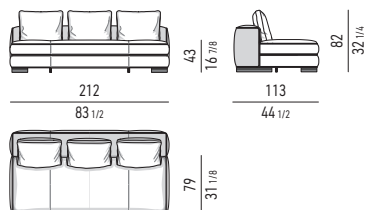

SUITE ELEMENTO CENTRALE CM 238
SUITE CENTRAL ELEMENT CM 238

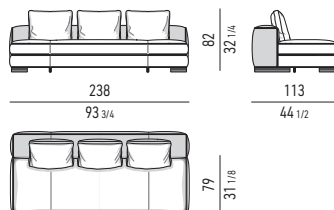

SUITE ELEMENTO CENTRALE CM 264
SUITE CENTRAL ELEMENT CM 264

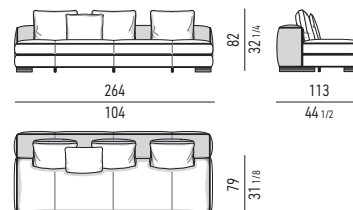

ELEMENTI PENISOLA | OPEN-END ELEMENTS

SUITE ELEMENTO PENISOLA CM 186
SUITE OPEN-END ELEMENT CM 186

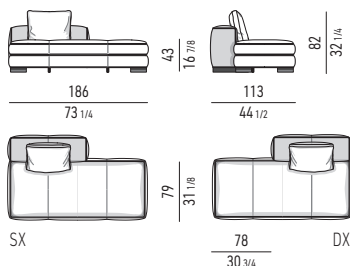

SUITE ELEMENTO PENISOLA CM 212
SUITE OPEN-END ELEMENT CM 212

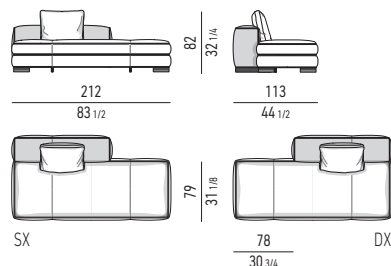

SUITE ELEMENTO PENISOLA CM 238
SUITE OPEN-END ELEMENT CM 238

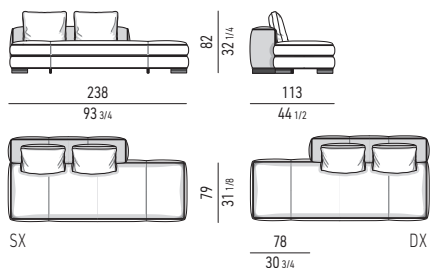

SUITE ELEMENTO PENISOLA CM 264
SUITE OPEN-END ELEMENT CM 264

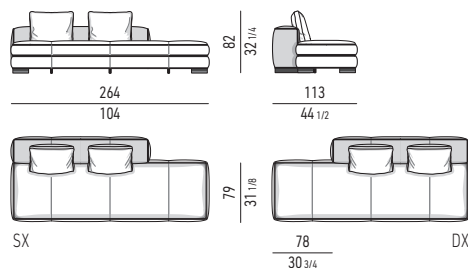

Minotti

COUCH | COUCHES

SUITE COUCH CM 134X191
SUITE COUCH CM 134X191

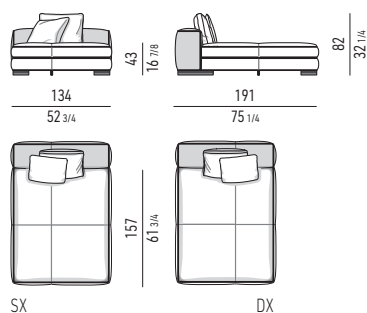

SUITE COUCH CM 160X191
SUITE COUCH CM 160X191

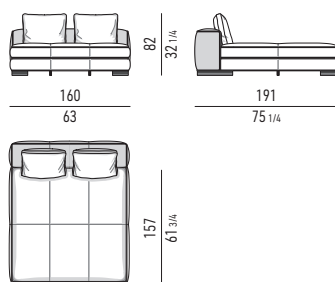

CHAISE-LONGUES

SUITE CHAISE-LONGUE CM 165X191
SUITE CHAISE-LONGUE CM 165X191

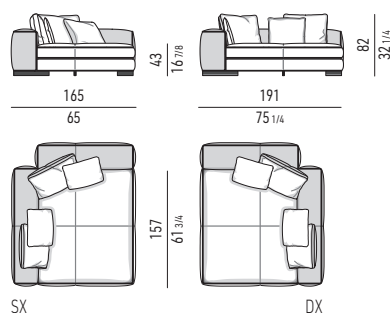

SUITE CHAISE-LONGUE CM 191X191
SUITE CHAISE-LONGUE CM 191X191

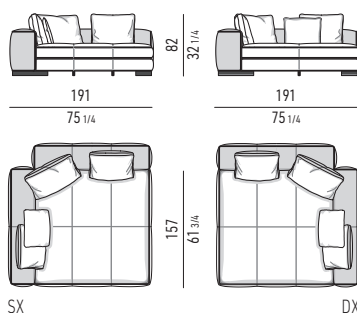

POUF | OTTOMANS

SUITE POUF CM 134X82
SUITE OTTOMAN CM 134X82

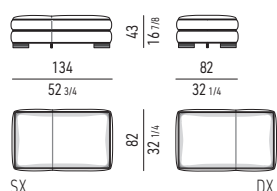

SUITE POUF CM 160X82
SUITE OTTOMAN CM 160X82

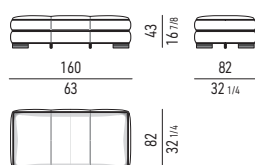

SUITE POUF CM 82X82
SUITE OTTOMAN CM 82X82

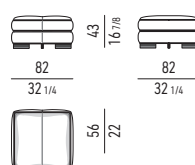

SUITE POUF CM 113X113
SUITE OTTOMAN CM 113X113

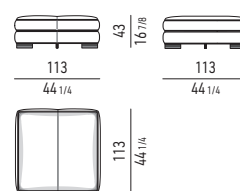

CUSCINI OPTIONAL | OPTIONAL CUSHIONS

CUSCINO SCHIENALE OPTIONAL CM 75X65
OPTIONAL BACKREST CUSHION CM 75X65

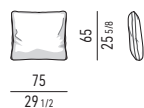

CUSCINO SCHIENALE OPTIONAL CM 60X55
OPTIONAL BACKREST CUSHION CM 60X55

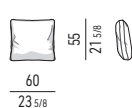

CUSCINO OPTIONAL CM 50X50
OPTIONAL CUSHION CM 50X50

