

ZENIT DAY

Rimadesio



THE ICONIC BOOKCASE IN THE PURSUIT OF LIGHTNESS AND PROJECT VERSATILITY. THE UPRIGHTS, FIXED FROM FLOOR TO CEILING AND ALWAYS CUSTOM-MADE, ALLOW A FREE POSITIONING OF THE ELEMENTS, IN THE DESIRED NUMBER AND AT THE DESIRED HEIGHT. THE EXCLUSIVE HOOKING SYSTEM ELEMENT GUARANTEES THE MAXIMUM STRUCTURAL SOLIDITY AND ALLOWS TO LEVEL EVERY ELEMENT.

IT La libreria all'insegna della leggerezza e della versatilità compositiva. I montanti, fissati da terra a soffitto e sempre su misura, permettono una libera disposizione delle attrezzature, nel numero e all'altezza desiderata. Un progetto versatile, pensato per esporre e contenere, destinato alla casa e agli spazi professionali. La varietà delle finiture, dal vetro alle essenze fino alle superfici in alluminio, consente una perfetta integrazione stilistica in ogni ambiente.

DE Das Bücherregal zeichnet sich durch Leichtigkeit und Vielseitigkeit aus. Die in Sondermaßen Pfosten, vom Boden bis zum Decke fixiert, ermöglichen dem Kunden eine freie Anordnung der Ausrüstung, in der gewünschten Anzahl und Höhe. Dies ist ein vielseitiges, für den häuslichen und professionellen Raum bestimmtes Modell, das entworfen wurde, um hergezeigt zu werden und um etwas zu verstauen. Die Vielfalt an Oberflächenmaterialien, von Glas über Holz bis zu den Aluminium-oberflächen, ermöglicht eine perfekte stilistische Integration in jeder Umgebung.

FR La bibliothèque caractérisée par la légèreté et la polyvalence de la composition. Les montants, fixés du sol au plafond et toujours sur mesure, permettent une disposition libre de l'équipement, dans le nombre et à la hauteur désirées. Un projet polyvalent, conçu pour exposer et contenir, destiné à la maison et aux espaces professionnels. La variété des finitions, du verre au bois, aux surfaces en aluminium, permet une intégration stylistique parfaite dans chaque environnement.

ES La librería se caracteriza por su ligereza y versatilidad compositiva. Los montantes, fijados al suelo y techo y siempre a medida, permiten una disposición libre del equipamiento, en el número y altura deseados. Un proyecto versátil, diseñado para exhibir y contener, destinado para el hogar y espacios profesionales. La variedad de acabados, del vidrio a las esencias y superficies de aluminio, permite una perfecta integración estilística en cualquier entorno.

RU Библиотека, характеризующаяся легкостью и композиционной универсальностью. Стойки, закрепленные в пол и потолок в полном соответствии с размерами заказчика, позволяют свободно размещать оснащение в нужном количестве и на нужной высоте. Универсальный дизайн, предназначенный для экспонирования и хранения, идеально впишется в домашний и профессиональный интерьер. Благодаря разнообразию вариантов отделки – от стекла до дерева и алюминиевых поверхностей – они могут идеально гармонировать с любым интерьером.

汉语 Zenit 书柜以轻巧和多样组合性著称。立柱皆按尺寸定制，固定于地板和天花板两端，可根据所需的配件数量和高度自由配置。多样的玻璃与木材表面处理以及铝合金打造的表面为任何空间皆能营造出完美风格感。



Structure: 13 nero
Glass shelves: 63 grigio trasparente
Fronts: 700 tinto ebano taiga
Marble top: 183 noir saint laurent
W 5090 H 2655 D 500

EN In the bookcase version, Zenit expands its design potential with the introduction of a brand new backlit upright and new suspended cabinets which, like all Zenit accessories, can be freely positioned. The aluminium drawers with fully extractable runners are equipped with a new push opening system and soft-closing mechanism. Drawers and hinged doors fronts are available in glossy, matt, sahara, taiga and diamante lacquered glass or in Litech, in sahara and taiga wood with a three-dimensional effect, with a total of 165 finishings.

IT Nella versione libreria Zenit amplia le proprie potenzialità progettuali con l'introduzione di un montante retroilluminato e di contenitori sospesi che, come tutte le attrezzature di Zenit, sono liberamente posizionabili. I cassetti in alluminio, con guide ad estrazione totale sono dotati di un inedito sistema di apertura push e rientro ammortizzato. Il rivestimento dei cassetti e delle ante è disponibile in vetro laccato lucido, opaco, sahara, taiga e diamante oppure in Litech, in essenza sahara e taiga con effetto tridimensionale, per un totale di 165 finiture.

DE In der Ausführung als Bücherregal erweitert Zenit sein Gestaltungspotenzial durch die Einführung einer hinterleuchteten Basis und von Hängeschränken, die, wie alle Zenit-Einrichtungen, frei positioniert werden können. Die Aluminium-Schubladen mit Vollauszug sind mit einem neuartigen Push-Open-System und Soft-Close-Rückführung ausgestattet. Die Paneele der Schubladen und Türen sind in glänzend oder matt lackiertem Glas, Taiga, Sahara und Diamante oder in Litech, Sahara- und Taigaholz mit dreidimensionalem Effekt erhältlich, insgesamt stehen 165 Ausführungen zur Verfügung.

FR Dans sa version bibliothèque, Zenit élargit son potentiel modulaire avec l'introduction d'un montant rétroéclairé et d'éléments de rangement suspendus qui, comme tous les équipements Zenit, peuvent être librement positionnés. Les tiroirs en aluminium, qui disposent de glissières entièrement extractibles, sont équipés d'un système inédit d'ouverture à pression avec amortisseur de fermeture. Le revêtement des tiroirs et des portes est disponible en verre laqué brillant, mat, sahara, taiga et diamante ou en Litech, dans les essences sahara et taiga avec effet 3D, pour un total de 165 finitions disponibles.

ES En su versión de librería, Zenit amplía su potencial de diseño espacial con la introducción de un inédito elemento vertical retroiluminado y contenedores suspendidos que, como todos los productos de Zenit, se pueden colocar libremente. Los cajones de aluminio, con guías totalmente extraíbles, cuentan con un inédito sistema de apertura push y retorno amortiguado. El revestimiento de cajones y puertas está disponible en vidrio lacado brillante, opaco, sahara, taiga y diamante o en Litech, en madera sahara y taiga con efecto tridimensional, para un total de 165 acabados.

RU В стеллажа Zenit расширяет свои собственные проектные возможности благодаря использованию стойки с подсветкой и подвесным ящикам для хранения, которые, как и все навесные элементы Zenit, можно размещать в любом месте. Алюминиевые ящики с направляющими полного выдвижения оснащены новой системой пуш-пулл с амортизаторами. Отделка ящиков и фасадов доступна из глянцевого, матового, крашеного стекла, а также декоративного стекла sahara, taiga и diamante, а также из Litech, шпона sahara и taiga с трехмерным эффектом – всего доступно 165 вариантов отделки.

汉语 Zenit 书柜扩大了设计潜力，推出背部照明式立柱和悬吊式收纳空间，如同 Zenit 的所有部件，它们皆可自由配置。铝合金打造的抽屉设有抽拉式导轨，并搭配新型推弹系统和软关闭功能。抽屉和门扇的表面处理有亮面漆和哑光漆玻璃、Sahara、Taiga、Diamante、和 Litech 岩板可供选择；Sahara 木材和 Taiga 木材具有立体效果，共有 165 表面处理可供选择。



Structure: 13 nero
Glass shelves: 63 grigio trasparente
Fronts: 700 tinto ebano taiga
Marble top: 183 noir saint laurent
Internal drawers in synthetic leather: 156 rubens



Structure: 13 nero
Glass shelves: 63 grigio trasparente
Fronts: 700 tinto ebano taiga
Synthetic leather Internal door covering: 156 rubens
Internal back panel: 68 specchio grigio

EN The indirect lighting system allows a latest generation LED to be inserted into the iconic upright which is only 25 mm wide, keeping the design of the original 1997 ceiling and wall fixing system unchanged. Thus, the Zenit bookcase system can be updated and improved over time without replacements or aesthetic variations, in line with the sustainability and durability common to the Rimadesio collection.

IT Il sistema di illuminazione a luce indiretta permette di inserire un led di ultima generazione nell'iconico montante di soli 25 mm di larghezza, mantenendo immutato il design del sistema di fissaggio a soffitto e a parete originale del 1997. In questo modo, il sistema libreria Zenit viene aggiornato e migliorato nel tempo senza sostituzioni né variazioni estetiche, in un'ottica di sostenibilità e durabilità comune agli arredi Rimadesio.

DE Das indirekte Beleuchtungssystem ermöglicht es, eine hochmoderne LED in der ikonischen Decken- und Wandmontagesystems von 1997 beizubehalten. Auf diese Weise wird das Bücherregalsystem Zenit im Laufe der Zeit aktualisiert und verbessert, ohne dass es ersetzt oder ästhetisch verändert werden muss, unter dem Aspekt der Nachhaltigkeit und Langlebigkeit, die für die Möbel von Rimadesio selbstverständlich sind.

FR Le système d'éclairage indirect permet d'insérer une LED de dernière génération dans le montant emblématique de seulement 25 mm de large, en conservant intact le design du système de fixation au plafond et au mur, dont l'origine remonte à 1997. Le système de bibliothèque Zenit est ainsi actualisé et amélioré au fil du temps sans remplacements ni modifications esthétiques, dans cette optique éco-responsable et durable propre aux meubles Rimadesio.

ES El sistema de iluminación indirecta permite insertar un LED de última generación en el icónico montante de solo 25 mm de ancho, manteniendo intacto el diseño del sistema original de fijación a techo y a pared de 1997. De esta forma, el sistema de librería Zenit se actualiza y mejora en el tiempo sin sustituciones ni variaciones estéticas, con la mirada puesta en la sostenibilidad y la durabilidad propias del mobiliario Rimadesio.

RU Система непрямого освещения позволяет встроить современный светодиод в культовую стойку шириной всего 25 мм, сохранив при этом дизайн оригинальной системы крепления к потолку и стене 1997 года. Таким образом, без значительных эстетических изменений система книжных шкафов Zenit была обновлена и улучшена в соответствии с современными тенденциями с целью обеспечения устойчивости и долговечности, характерных для мебели Rimadesio.

汉语 间接照明系统能将最新一代的 LED 灯嵌入宽度仅 25 毫米的经典款立柱内，保留了 1997 年天花板和墙面固定系统的设计。通过此法，Zenit 改良书柜系统与与时俱进，不断更新改良，美感却始终如一，进而体现 Rimadesio 家具可持续发展性和耐用性的共同点。

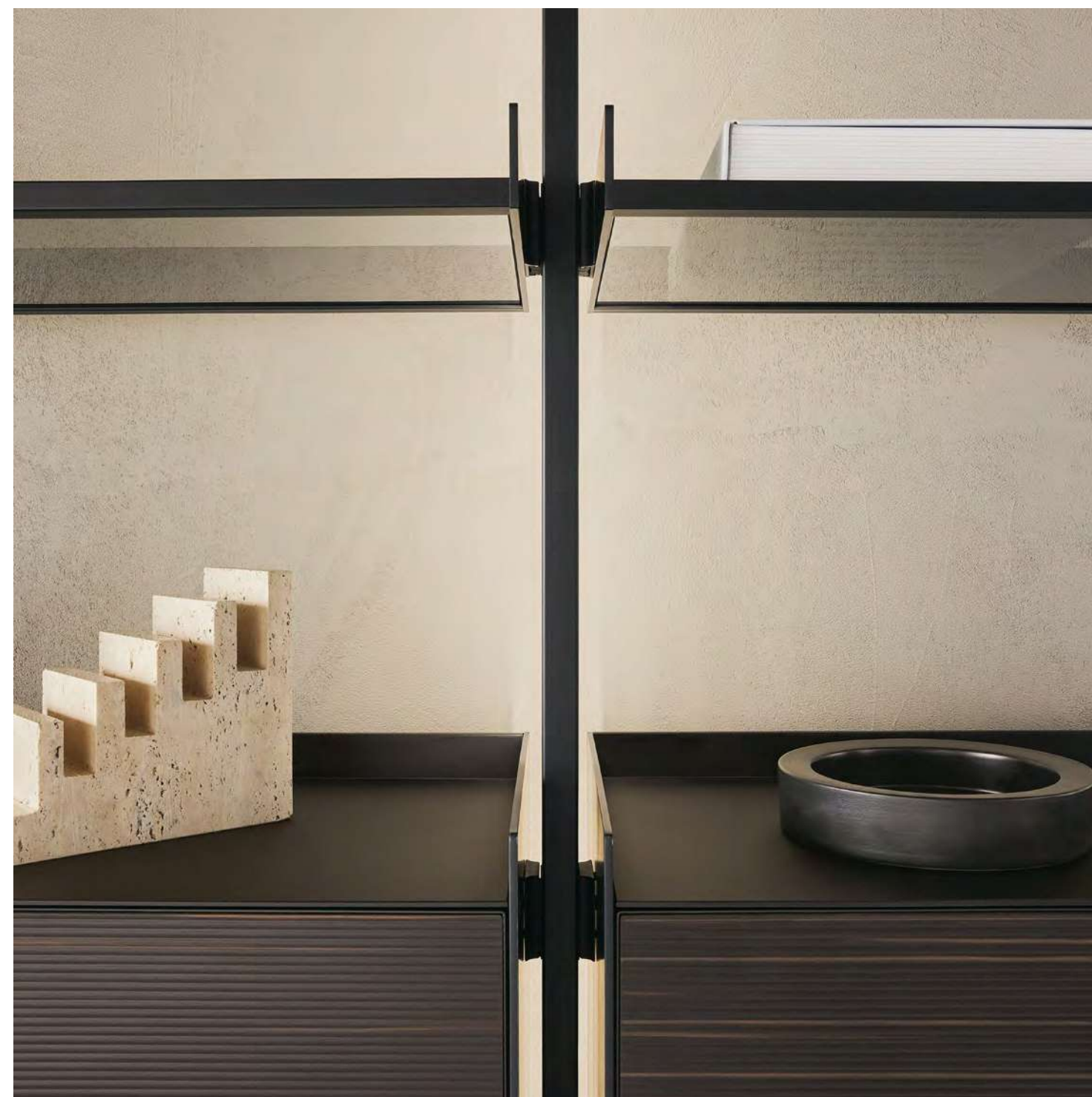

Structure: 13 nero
Glass shelves: 63 grigio trasparente
Fronts: 700 tinto ebano taiga





EN The aluminium upright guarantees the maximum structural solidity. The bayonet fixing system allows every single element to be installed perfectly leveled. The wall and ceiling uprights allow any possible composition.

IT Il montante in alluminio garantisce la massima solidità strutturale alle composizioni Zenit e il sistema di aggancio a baionetta consente di posizionare in bolla ogni singolo elemento. I montanti sono disponibili "a soffitto" e "a parete" per consentire la collocazione del sistema in ogni ambiente.

DE Der Montageposten aus Aluminium garantiert eine maximale Stabilität für eine Zenit Kompositionen und das Bajonettkupplungssystem ermöglicht ein waagerechte Positionierung jedes einzelnen Elements. Diese Montageposten sind als Decken- und Wand-Montage erhältlich, sodass das System in jeder Raum platziert werden kann.

FR Le montant en aluminium garantit une solidité structurelle maximale aux compositions Zenit et le système de fixation à baïonnette permet de positionner à niveau chaque élément individuel. Les montants sont disponibles à plafond et à mur pour permettre au système d'être positionné dans n'importe quel environnement.

ES El montante de aluminio garantiza la máxima solidez estructural a las composiciones Zenit y el sistema de fijación permite colocar cada elemento individual a nivel. Los montantes están disponibles "a techo" y "a pared" para permitir de colocar el sistema en cualquier situación.

RU Алюминиевая стойка гарантирует максимальную конструктивную прочность композициям Zenit, а бесшаговая система крепления позволяет выставить по уровню каждый из навесных элементов. Стойки могут крепиться к потолку или к стене, что позволяет установить систему в любом помещении.

汉语 铝制立柱保证了结构的最大坚固性。卡口式固定系统使每个元件都能完美地安装在水平面上。墙壁和天花板立柱允许任何可能的组合。

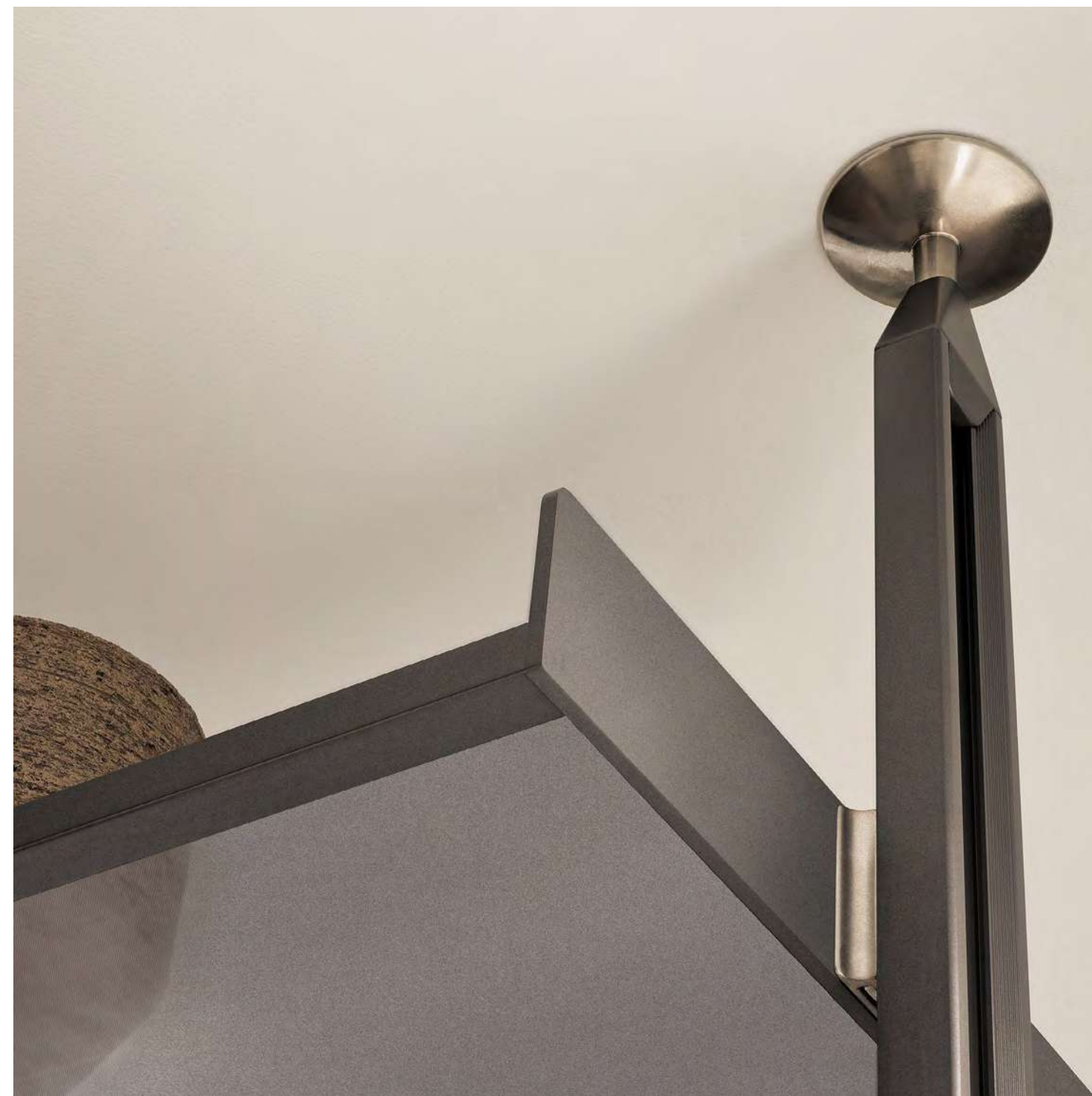







Structure: 304 platino
Fronts: 17 noce sahara
Glass shelves: 61 rete inox
Glass top: 137 platino opaco
W 6090 H 3000 D 500



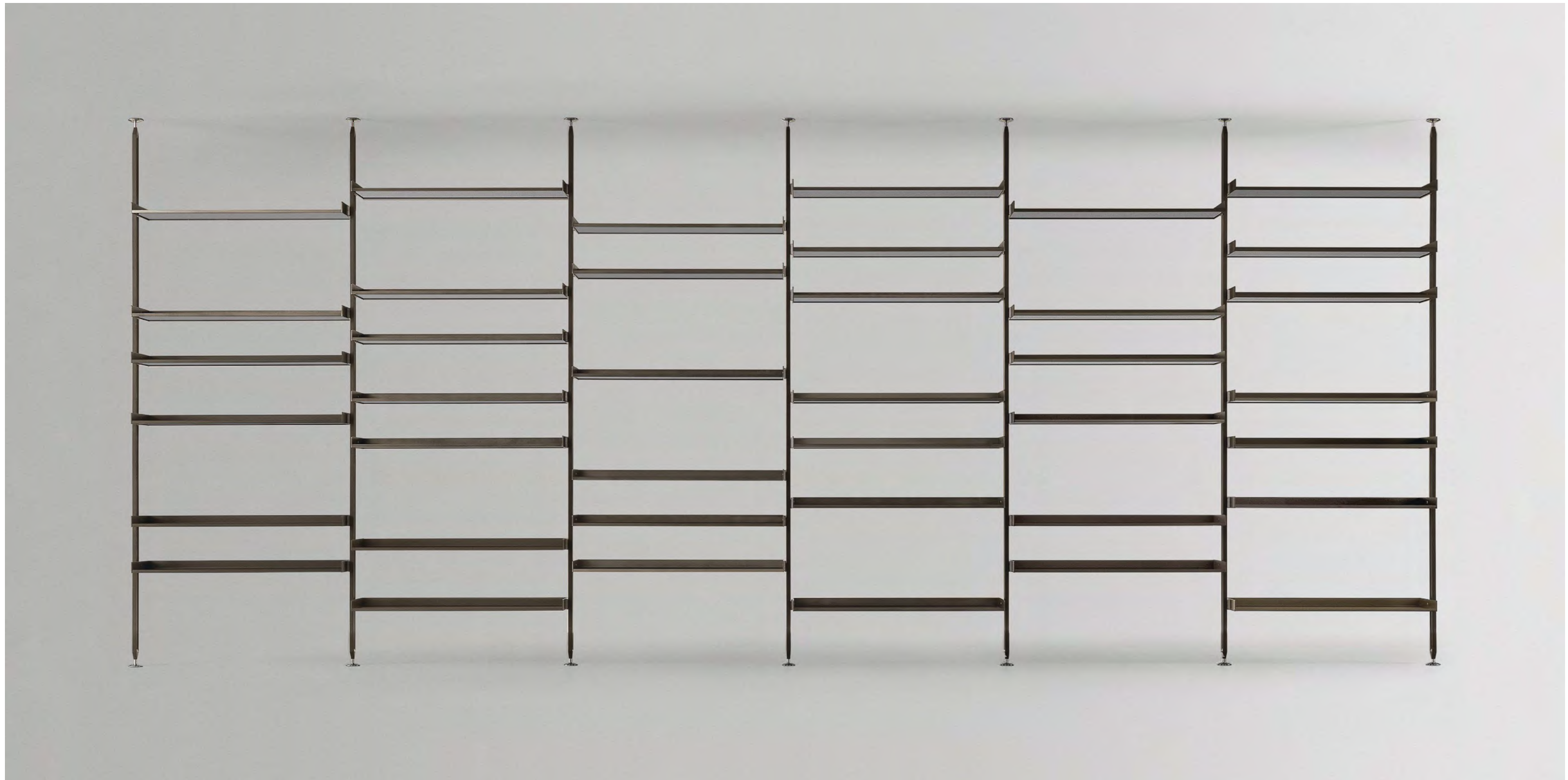



Structure: 304 platino
Suspended drawer unit: 404 platino diamante
Glass shelves and suspended glass cabinets:
00 trasparente
W 5090 H 2700 D 500

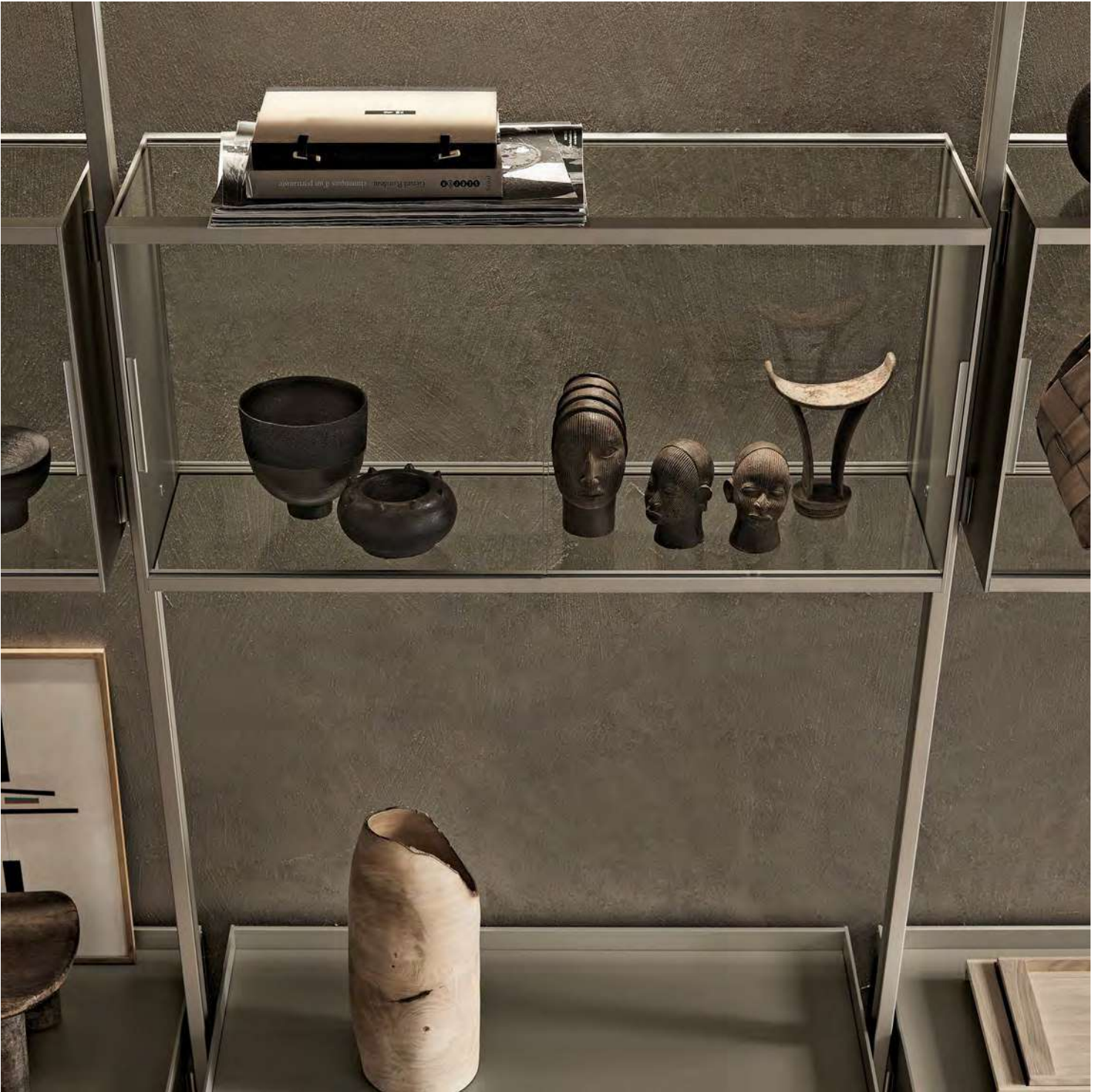

Structure: 304 platino
Suspended glass cabinet: 00 trasparente

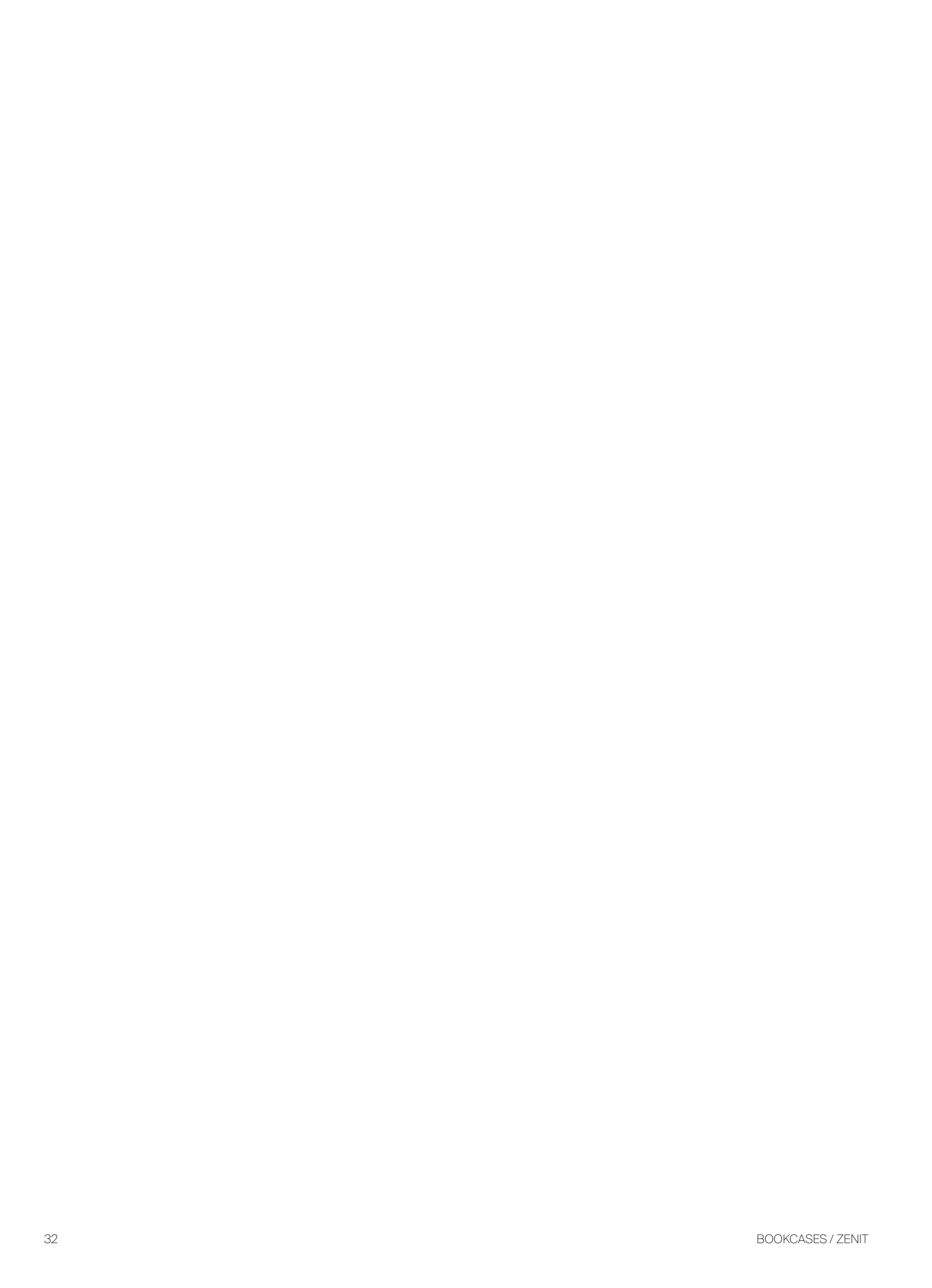



Zenit bookcase

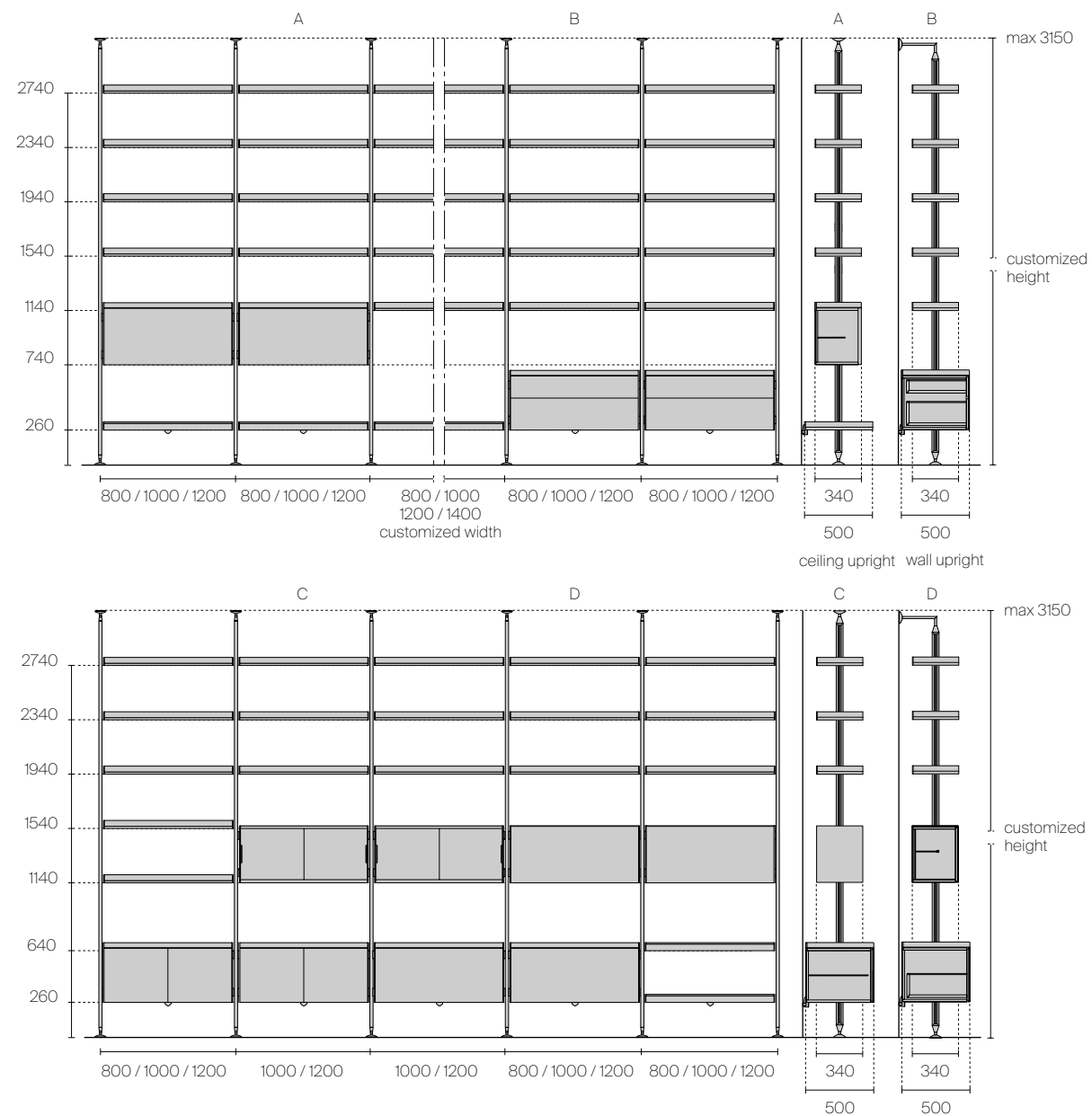

Encumbrance of the linear composition with shelves only

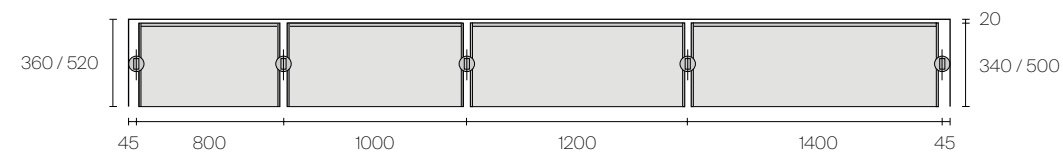

TECHNICAL DESCRIPTION

EN Zenit compositions are always custom-made in height, with wall or ceiling uprights. Shelves and TV shelf holders are available in four widths, up to a maximum size of 1400 mm.

IT Le composizioni Zenit vengono sempre realizzate su misura in altezza, con possibilità di montanti a parete o a soffitto. Le mensole e i mensoloni sono disponibili in quattro larghezze, fino alla dimensione massima di 1400 mm.

DE Zenit Anlage sind immer nach Mass in Hoehe, mit Wand oder Decke-Pfosten hergestellt. Fachboeden und Top-Fachboeden sind mit vier Breiten verfuegbar in larghezza, bis zu einer maximalen Breite von 1400 mm.

FR Les compositions Zenit sont toujours sur mesure en hauteur, avec les montants à fixation murale ou au plafond. Les étagères, et les étagères base sont disponibles en quatre largeurs, jusqu' à une dimension maxi de 1400 mm.

ES Las composiciones Zenit están siempre realizadas a medida en altura, con posibilidad de montantes a pared o a techo. Los estantes, y los estantes base están disponibles en cuatro anchuras, máxima medida de 1400 mm.

RU Композиции Zenit всегда изготавливаются по индивидуальному размеру по высоте, с возможностью настенного или потолочного монтажа стоек. Полки доступны в четырех размерах по ширине, вплоть до Максимальных 1400 мм.

汉语 Zenit 组合件的高度皆按尺寸定制，立柱可安装于墙面或天花板。层板和层板托有四种宽度可供选择，最大尺寸为 1400 毫米。

TV Hi-Fi shelf holder with lower shelf for decoder

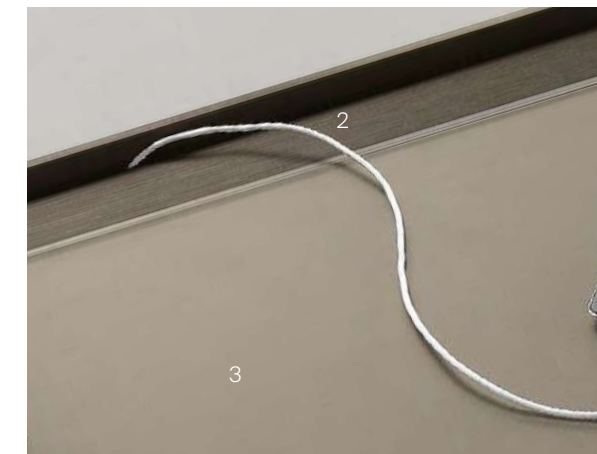

1. Aluminium support for decoder in 14 brown
2. Aluminium cable channeling in 14 brown
3. Lacquered tempered glass in 99 caffè

UPRIGHTS



1. Ceiling upright
2. Wall upright
3. Shelf with perimetrical ring in extruded aluminium
4. Bayonet fixing between the shelf and the die casting support
5. Structural upright in extruded aluminium
6. Support with expansion fixing system which allows to adjust the position of the accessories



Ceiling

Ceiling backlighted

Wall

Wall backlighted

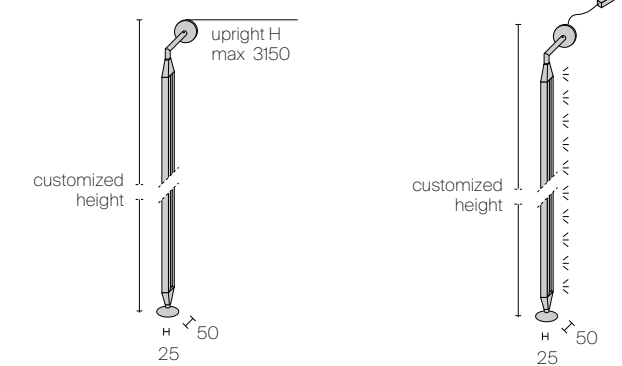
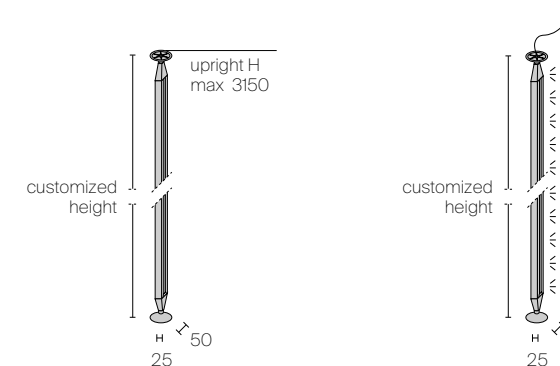

Suspended unit with drawers

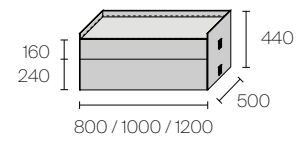

Suspended unit with drawer and flap door

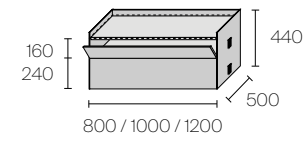

Suspended unit with drawer

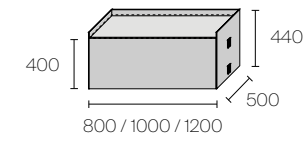

Suspended unit with hinged doors

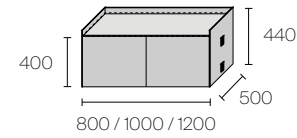

Suspended unit with flap door high side

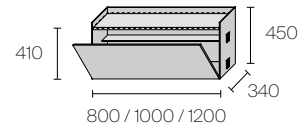

Suspended unit with flap door low side

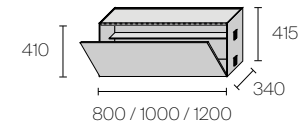

Suspended glass cabinet with sliding doors

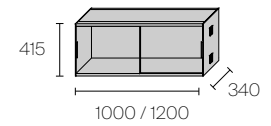

Optional glass shelf. Available for unit with hinged doors.

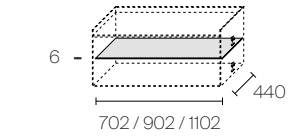

Optional synthetic leather mat for internal lining

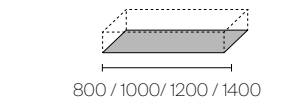

Glass finishing top thickness 4mm

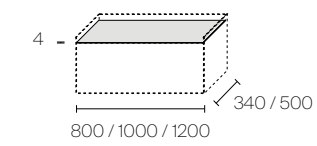

Litech finishing top thickness 4mm

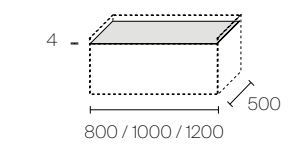

Marble finishing top thickness 20mm

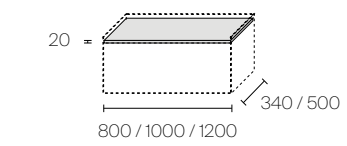

Glass shelf

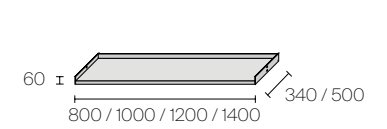

Glass shelf covered with synthetic leather

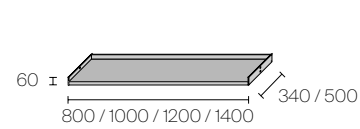

TV Hi-Fi shelf holder in lacquered glass with support for decoder

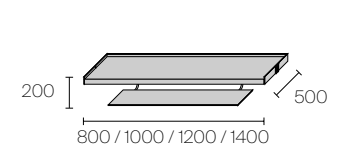

Optional adjustable wall thrust block



Optional cable duct for units depth 500. Not available for units with marble top.

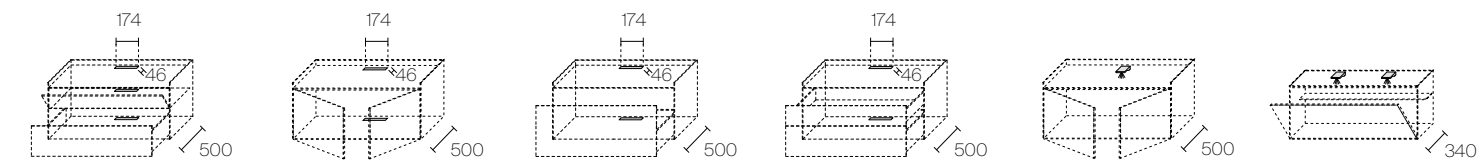

Battery led spotlight

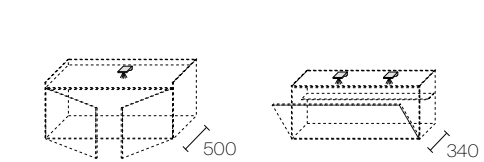

1



2



3



4



5



6



7

1. Suspended unit with drawers
2. Suspended unit with drawer and flap door
3. Suspended unit with drawer
4. Suspended unit with hinged doors
5. Suspended unit with flap door D 340 low side
6. Suspended unit with flap door D 340 high side
7. Suspended glass cabinet with sliding doors

Structure and accessories

ALUMINIUM

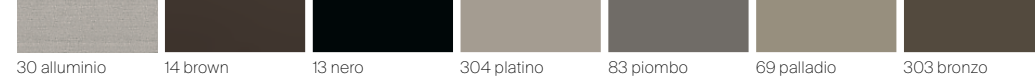

Suspended glass cabinet

TRANSPARENT GLASS

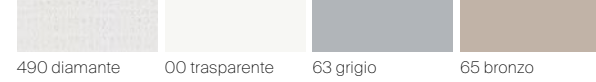

SATINATED GLASS

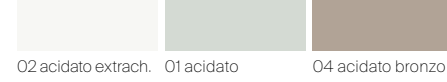

Suspended units

LACQUERED GLASS METALIZED GLASS



SAHARA GLASS



TAIGA GLASS



SAHARA METALIZED GLASS



TAIGA METALIZED GLASS



DIAMANTE GLASS



LITECH



SAHARA WOOD

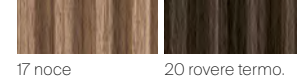

TAIGA WOOD

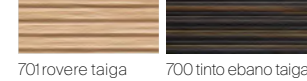

Finishing top for suspended units

LACQUERED GLASS METALIZED GLASS

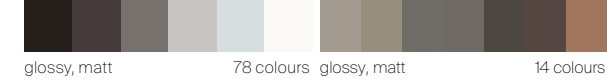

DIAMANTE GLASS

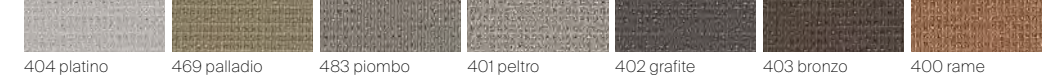

MARBLE



MATT MARBLE

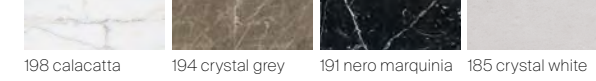

LITECH



Unit interior D 340

ALUMINIUM

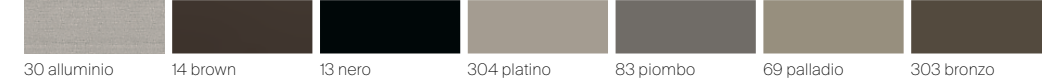

Unit interior D 500

INTERNAL MELAMINE



Shelf

TRANSPARENT GLASS

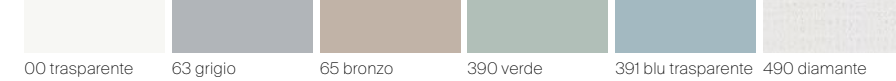

SATINATED GLASS

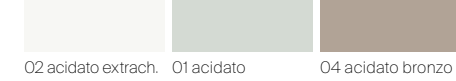

MESH GLASS



SYNTHETIC LEATHER



TV Hi-Fi shelf holder

LACQUERED GLASS METALIZED GLASS



Mat for internal lining, internal flap door lining of units D 340

SYNTHETIC LEATHER



QUALITY AS THE MAIN PURPOSE, ALWAYS AND IN EVERY ASPECT, WITH THIS MISSION RIMADESIO IS CONSTANTLY SEARCHING FOR SOLUTIONS TO IMPROVE ITS OWN ECOLOGICAL STANDARDS.

OBJECTIVE OBTAINED THANKS TO THE USE OF PRECIOUS AND RECYCLABLE MATERIALS, TO THE ABSENCE OF SUBSTANCES THAT CAN BE TOXIC TO HUMANS OR HARMFUL TO THE ENVIRONMENT IN EVERY PHASE OF THE PRODUCTIVE PROCESS, TO THE USE OF TECHNOLOGY AND EVOLVED MACHINERY, POWERED BY CLEAN ENERGY DERIVED FROM PHOTOVOLTAIC SYSTEMS, INSTALLED ON THE GIUSSANO HEADQUARTERS ROOF.

ALUMINIUM, GLASS, WOOD: FULLY RECYCLABLE AND PARTLY ALREADY RECYCLED MATERIALS.

PROOFS OF A REINFORCED GREEN DNA AND WIDE COHERENCE, SIGNALS OF A CONTINUOUS RESEARCH AND A GLANCE TOWARDS THE FUTURE, THAT TAKES SHAPE IN THE TECHNOLOGICAL INNOVATION OF SYSTEMS, DOORS AND FURNITURE, MADE WITH THE AWARENESS OF WANTING TO ENTRUST HUMANS ONLY WITH HIGH VALUE-ADDED ACTIVITIES.

EXCELLENCE SUSTAINABILITY PROJECT

IT Perseguire la qualità, sempre, sotto tutti gli aspetti. Con questa mission Rimadesio ricerca costantemente soluzioni volte a migliorare i propri standard qualitativi ecologici. Obiettivo ottenuto sinergicamente, grazie all'utilizzo di materiali preziosi e riciclabili, all'assenza di sostanze tossiche per l'uomo e nocive per l'ambiente in ogni fase del processo produttivo, all'impiego di tecnologie e macchinari evoluti alimentati con energia pulita proveniente da impianti fotovoltaici, installati sulla copertura dell'headquarter di Giussano. Alluminio, vetro, legno, materiali totalmente riciclabili e in parte già riciclati, ma anche le vernici prive di solventi di Ecoloursystem e i sistemi di imballaggio ecologici. Testimonianze di un dna green consolidato e di una coerenza trasversale, segnali di una continua attività di ricerca e di uno sguardo sempre proteso al futuro che si declina nell'innovazione tecnologica di sistemi, porte ed arredi, realizzati con la consapevolezza di voler affidare all'uomo solo attività dall'alto valore aggiunto.

DE Stets um Qualität bemüht, und zwar in allen Bereichen. Mit dieser Mission im Blick sucht Rimadesio laufend nach Lösungen, um seine ökologischen Qualitätsstandards zu verbessern. Dieses Ziel wurde dank der Verwendung wertvoller und wiederverwertbarer Materialien, dem Verzicht auf für den Menschen giftige und umweltschädliche Stoffe in jeder Phase des Produktionsprozesses und dem Einsatz fortschrittlicher Technologien und Maschinen, die mit sauberer Energie aus den auf dem Dach des Giussano-Hauptsitzes installierten Photovoltaikanlagen betrieben werden, synergetisch erreicht. Aluminium, Glas, Holz, vollständig recycelbare und teilweise bereits recycelte Materialien, aber auch die Lösungsmittelfreien Farben von Ecoloursystem und umweltfreundliche Verpackungssysteme. Ein Zeugnis einer fundierten grünen DNA und einer transversalen Kohärenz, Zeichen einer kontinuierlichen Forschungstätigkeit und eines stets in die Zukunft gerichteten Blicks, der sich in der technologischen Innovation von Systemen, Türen und Einrichtungsgegenständen ausdrückt, die in dem Bewusstsein realisiert werden, den Menschen nur Tätigkeiten mit hohem Mehrwert anzuvertrauen.

FR Poursuivre la qualité, toujours, et à tous les égards. Avec cette mission Rimadesio recherche constamment de solutions au fin d'améliorer ses normes de qualité écologique. Objectif atteint, grâce à l'utilisation de matériaux précieux et recyclables, l'absence à chaque étape de la production de substances toxiques nocives pour l'homme et l'environnement, l'utilisation de technologies et des machines avancées alimentées par l'énergie solaire après l'installation sur le toit de l'usine à Giussano de systèmes photovoltaïques. Aluminium, verre, bois, des matériaux entièrement recyclables et déjà en partie recyclés, mais aussi peinture Ecoloursystem sans solvants et systèmes d'emballage respectueux de l'environnement. Témoignages d'un adn "vert" consolidé et d'une cohérence transversale, signes de recherche continuelle et d'une tendance à regarder en avant, qui correspond bien à l'innovation technologique des systèmes, des portes et des meubles, réalisés avec la conscience que l'apport de l'homme dans la production ne peut qu'avoir un valeur ajoutée.

ES Perseguir la calidad, siempre, en todos los aspectos. Con esta misión Rimadesio busca constantemente soluciones destinadas a mejorar sus estándares de calidad ecológica. Objetivo conseguido sinérgicamente, gracias al uso de materiales preciosos y reciclables, a la ausencia de sustancias tóxicas para los seres humanos y nocivas para el medio ambiente en cada etapa del proceso de producción, al uso de tecnologías y máquinas avanzadas alimentadas por energía limpia a partir de sistemas fotovoltaicos, instalados en la cobertura del headquarter de Giussano. Aluminio, cristal, madera, materiales completamente reciclables y, en parte, ya reciclados, sino también las pinturas Ecoloursystem libres de disolventes y los sistemas de embalaje ecológicos. Testimonios de un adn green consolidado y una coherencia transversal, señales de una continua investigación y de una vista siempre tendida al futuro que se declina en la innovación tecnológica de sistemas, puertas y muebles, realizados con el conocimiento que desea confiar al hombre sólo actividades de alto valor añadido.

RU Обеспечение качества всегда и во всем. И, в том числе, для достижения этой цели Компания Rimadesio находится в постоянном поиске решений, направленных на улучшение экологических стандартов качества. Эта цель была достигнута благодаря использованию на каждом этапе производственного процесса ценных материалов, пригодных для вторичной переработки, отсутствию токсичных для человека и вредных для окружающей среды веществ, а также благодаря внедрению передовых технологий и оборудования, работающего на чистой энергии от фотоэлектрических систем, установленных на крыше штаб-квартиры компании в г. Джуссано. Компания использует такие материалы, как алюминий, стекло, дерево – полностью перерабатываемые и уже частично переработанные материалы, краски Ecoloursystem, не содержащие растворителей, а также экологически упаковку. Свидетельство консолидированной экологичности и непрерывной последовательности, исследовательской деятельности и взгляда, всегда устремленного в будущее, что выражается в технологических инновациях систем, дверей и мебели, произведенных с осознанием того, что человеку стоит поручать только деятельность с высокой добавленной стоимостью.

汉语 始终至终追求全方位的卓越品质。Rimadesio 肩负使命，不断探索精进生态质量标准的解决方案。品牌目标之达成有赖于珍贵的可回收材料，该材料在所有制造阶段皆不会产生危害人体和环境之有毒物质，同时结合业界前沿的技术以及先进机械装置；而位于朱塞诺 (Giussano) 品牌总部建筑屋顶上的光伏发电设备为上述之机械装置供给干净的能源。除了可完全回收和已部分回收的铝材、玻璃、木材等材料之外，还有环保色彩系统 (Ecoloursystem) 的无溶剂涂料和生态环保型包装。深植的绿色 DNA、跨领域的协同性、持续的研究工作以及具前瞻性的未来展望皆体现在家具系统、各式门类 and 家具配件的技术创新上，其本着信赖人类才能胜任高附加价值活动的意念研发而成。

GUIDE TO RIMADESIO QUALITY

TEMPERED GLASSES

Single tempered glasses cooked at a temperature of 650 °C. Mechanical resistance 5 times superior in comparison to a normal glass. In case of breaking it crumbles in harmless tiny fragments. In accordance with the UNI EN 12150, UNI 7697 and UNI EN 12600 rules with reference to the security of glasses for decoration purposes.

LAMINATED GLASSES

Double glasses. Between the two glasses a thin plastic film is inserted. Transparent and invisible, it perfectly sticks to both surfaces. Both surfaces are perfectly smooth.Resistance to breaking in accordance with the UNI EN ISO 12543, UNI 7697 and UNI EN 12600 rules. The plastic film witholds the fragments in case of breaking.

GLASS WITH METAL NET AND MESH

Double laminated glasses. Between the two extra-clear glasses and two thin plastic films a micronet fabric is inserted. Through a sophisticated process a metal layer is applied on the fabric, thus creating a characteristic effect of semi transparency. The reflections of the light on the surface of the metallic net are provided by using an extra-clear float glass, which allows maximum transparency and high light transmissions, thanks to the low content of iron oxides. Following the process of hot stratification, the fabric might show minor wave effect, which give the material its characteristic materic and natural look.

ECOLORSYSTEM LACQUERED GLASSES

Ecolorsystem is the name that distinguishes the exclusive Rimadesio lacquered glass collection in glossy and matt finishing. Ecological colours produced using exclusively water paints of latest generation, cooked at 110° C. A production technology in the area of glass, with a fully robotised in-house plant that ensures very high quality results and a low environmental impact work cycle. Corrosion resistance conforms to the UNI EN ISO 9227 standard. Temperature fluctuation resistance conforms to the UNI 9429 standard. The colour is inside the double glass, safe from stains, dust and humidity. The thickness of the glass creates an exclusive "depth" effect.

VETRI TEMPERATI

Vetri singoli, sottoposti al trattamento della tempra ovvero ad una cottura alla temperatura di 650 °C. Resistenza meccanica di 5 volte superiore rispetto ad un vetro normale. In caso di rottura si sbriciola in minuti frammenti inoffensivi. Conformi alle norme UNI EN 12150, UNI 7697 e UNI EN 12600 in materia di sicurezza per i vetri d'arredamento.

VETRI STRATIFICATI

Vetri doppi. Fra i due vetri è inserita una sottile pellicola di materiale plastico, trasparente ed invisibile, che aderisce completamente alle due superfici. Entrambe le superfici sono perfettamente lisce. Resistenza alla rottura conforme alle norme UNI EN ISO 12543, UNI 7697 e UNI EN 12600. La pellicola di materiale plastico in caso di rottura trattiene i frammenti.

VETRI STRATIFICATI RETE, MAGLIA E FIBRA

Vetri doppi stratificati. Tra i due vetri extra-chiari e le due sottili pellicole in materiale plastico, è inserito un tessuto in microrete sul quale, tramite un sofisticato processo di materizzazione, viene depositato uno strato metallico che crea un caratteristico effetto di semitrasparenza. Le riflessioni della luce sulla superficie della rete metallizzata sono ottenute con l'utilizzo del vetro float extrachiario che, grazie al basso contenuto di ossidi di ferro, garantisce la massima trasparenza e un'elevata trasmissione luminosa. Il tessuto, a seguito del processo di stratifica a caldo, può presentare delle leggere ondulazioni che conferiscono al materiale il suo caratteristico aspetto materico e naturale.

VETRI LACCATI ECOLORSYSTEM

Ecolorsystem è la denominazione che contraddistingue l'esclusiva collezione di vetri laccati Rimadesio, disponibili in finitura lucida e opaca. Colori ecologici perché prodotti utilizzando esclusivamente vernici all'acqua di ultima generazione, con cottura a 110°C. Una tecnologia produttiva all'avanguardia nell'ambito del vetro, con impianti interni totalmente robotizzati che assicurano risultati di altissima qualità e un ciclo di lavorazione a basso impatto ambientale. Resistenza alla corrosione conforme alla norma UNI EN ISO 9227. Resistenza agli sbalzi di temperatura conforme alla norma UNI 9429. Colori inalterabili nel tempo perché applicati sulla superficie interna del vetro, al sicuro da macchie, polvere e umidità. Lo spessore del vetro crea un esclusivo effetto di "profondità".

TEMPERIERTES GLAS

Einzelgläser, die einer Härtingsbehandlung oder einer Kochtemperatur von 650 °C unterzogen wurden. Mechanische Beständigkeit 5 mal höher als bei normalem Glas. Im Bruchfall zerbröckeln harmlose Bruchstücke in Minuten. Entspricht den Normen UNI EN 12150, UNI 7697 und UNI EN 12600 für die Sicherheit von Möbelgläser.

SCHICHTGLAS

Doppelgläser. Zwischen den beiden Gläsern befindet sich ein dünner Film aus transparentem und unsichtbarem Kunststoff, der vollständig an den beiden Oberflächen haftet. Beide Oberflächen sind komplett glatt. Die Bruchfestigkeit entspricht den Normen UNI EN ISO 12543, UNI 7697 und UNI EN 12600. Die Kunststofffolie bewahrt im Bruchfall die Bruchstücke.

SCHICHTGLAS MIT METALLNETZ, GLASGITTER UND FASER

Hierbei handelt es sich um Doppel-schichtgläser. Zwischen den zwei Extralight-Glasscheiben und den beiden unsichtbaren Plastikfolien wird ein Metallnetz deposited auf ce tissu, créant un effet caractéristique translucide. Les reflets de la lumière sur la surface de la maille métallique sont obtenus avec l'utilisation du verre float extra clair, qui, grâce à un faible teneur de oxydes de fer, permet un maximum de transparence et de transmission de la lumière. Suite au procédé de stratification à chaud, le tissu peut présenter de petites ondulations, qui apportent au matériau son aspect caractéristique et naturel.

LACKIERTE GLÄSER ECOLORSYSTEM

Ecolorsystem ist der Name der lackierten Glas-Kollektion von Rimadesio in der glänzend und matte Ausführung verfügbar. Absolut oekologische Farben, da die modernsten Lackierungen, auf Wasser-Basis, an einer Temperatur von 110° gekocht werden. Eine fortschrittliche Produktionstechnik in der Glasverarbeitung auf einer vollautomatisierten Anlage, die Ergebnisse höchster Qualität und gleichzeitig umweltfreundliche Verarbeitungsverfahren gewährleistet. Korrosion-sprüfung gemäß Bestimmung UNI EN ISO 9227. Temperaturwechselprüfung gemäß Bestimmung UNI 9429. Unverändliche Farben da die Farbung sich im Innen des Doppelglases, geschützt vor Staub, Kratzen und Feuchtigkeit, befindet. Die Dicke des Glases erzeugt eine einzigartige Tiefwirkung.

VERRES TREMPÉS

Verres simples, soumis au traitement de trempe et donc à une température de cuisson de 650 °C. Résistance mécanique 5 fois supérieure à celle du verre normal. En cas de rupture, des fragments inoffensifs s'effritent en quelques minutes. Conforme aux normes UNI EN 12150, UNI 7697 et UNI EN 12600 pour la sécurité des verres pour les meubles.

VERRES STRATIFIÉS

Double verres. Entre les deux verres se trouve une fine pellicule de matière plastique, transparente et invisible, qui adhère complètement aux deux surfaces. Les deux surfaces sont parfaitement lisses. La résistance aux ruptures est conforme aux normes UNI EN ISO 12543, UNI 7697 et UNI EN 12600. La pellicule retient les fragments en cas de rupture.

VERRE FEUILLETÉ AVEC NET, MAILLE ET FIBRA

Double verre stratifié. Entre les deux verres extra clair et les deux films fins de matière plastique un tissu en micro maille est ajouté. A travers un procédé avancé de materisation un couche métallique est déposé sur ce tissu, créant un effet caractéristique translucide. Les reflets de la lumière sur la surface de la maille métallique sont obtenus avec l'utilisation du verre float extra clair, qui, grâce à un faible teneur de oxydes de fer, permet un maximum de transparence et de transmission de la lumière. Suite au procédé de stratification à chaud, le tissu peut présenter de petites ondulations, qui apportent au matériau son aspect caractéristique et naturel.

VERRES LAQUÉS ECOLORSYSTEM

Ecolorsystem est le nom qui caractérise la collection exclusive de verres laqués de Rimadesio disponibles en finition brillante et mate. Couleurs écologiques, parce que produits en utilisant exclusivement vernis à l'eau de dernière génération, cuites à 110°. Une technologie de production avant-gardiste dans le domaine du verre, avec des équipements internes entièrement robotisés qui assurent des résultats de grande qualité et un cycle de production ayant un impact très faible sur l'environnement. Résistance à la corrosion conformément à la norme UNI EN ISO 9227. Résistance aux écarts de température conformément à la norme UNI 9429. Couleurs inaltérables parce qu'ils sont appliqués dans la surface interne du verre, pour protéger de la poussière humidité et taches. L'épaisseur du verre crée un exclusif effet profondeur.

CRISTALES TEMPLADOS

Vidrios simples, sometidos al tratamiento de templado a una temperatura de cocción de 650 °C. Resistencia mecánica de 5 veces mayor que el vidrio normal. En caso de rotura, se desmoronan fragmentos inofensivos. Conforme a las normas UNI EN 12150, UNI 7697 y UNI EN 12600 en materia de seguridad para los cristales en el amueblamiento.

CRISTALES ESTRATIFICADO

Vidrios dobles. Entre los dos vidrios hay una película fina de material plástico, transparente e invisible, que se adhiere completamente a las dos superficies. Ambas superficies son perfectamente lisas. La resistencia a la rotura cumple con las normas UNI EN ISO 12543, UNI 7697 y UNI EN 12600. La película de plástico en caso de rotura retiene los fragmentos.

CRISTALES ESTRATIFICADOS RED METÁLICA, MAILLA Y FIBRA

Cristales dobles estratificados. Entre los dos cristales extraclaros y las dos capas sintéticas, está inserido en un tejido de microred en el que, a través de un sofisticado proceso se deposita una característica de efecto semitransparente. Los reflejos de la luz sobre la superficie de la red metálica se proporcionan con el uso del vidrio float extraclaro que, gracias a su bajo contenido en óxidos de hierro, asegura la máxima transparencia y una alta transmisión de luz. El tejido, siguiendo el proceso de estratificación en caliente, puede presentar ligeras ondulaciones que dan al material su aspecto característico natural.

CRISTALES LACADOS ECOLORSYSTEM

Ecolorsystem es la denominación que marca la exclusiva colección de los cristales lacados Rimadesio, disponibles en acabado brillante y mate. Colores ecológicos porque productos utilizando exclusivamente pinturas al agua de última generación, con cocción a 110°. Una tecnología productiva a la vanguardia en el ámbito del cristal, con unas instalaciones internas totalmente robotizadas que aseguran resultados de altísima calidad y un ciclo de tratamiento respetuoso del medio ambiente. Resistencia a la corrosión conforme a la norma UNI EN ISO 9227. Resistencia a las variaciones de temperatura conforme a la norma UNI 9429. Colores inalterables en el tiempo porque aplicados en la superficie interior del cristal, al resguardo de manchas, polvo y humedad. El grosor del cristal crea un exclusivo efecto de "profundidad".

ЗАКАЛЕННОЕ СТЕКЛО

Механическая прочность одинарных стекол, подвергнутых закалке, т.е. обжигу при температуре 650°С, в 5 раз выше, чем у обычного стекла. Если такое стекло разбить, оно рассыпется на мелкие неопасные осколки. Соответствует стандартам безопасности UNI EN 12150, UNI 7697 и UNI EN 12600 для мебельного стекла.

МНОГОСЛОЙНОЕ СТЕКЛО

Двойные стекла. Тонкая, прозрачная и невидимая пластиковая пленка прокладывается между двумя стеклами и полностью приклеивается к обеим поверхностям. Обе поверхности идеально гладкие. Проверка прочности на разрыв была выполнена в соответствии со стандартами UNI EN ISO 12543, UNI 7697 и UNI EN 12600. Эта пленка способна удерживать осколки разбившегося стекла.

МНОГОСЛОЙНОЕ СТЕКЛО, СТЕКЛО С СЕТКОЙ

Многослойное двойное стекло. Между двумя сверхпрозрачными стеклами и двумя тонкими пластиковыми пленками вставляется микросетчатое полотно, на которое в ходе сложного производственного процесса наносится металлический слой, благодаря чему и формируется характерный полупрозрачный эффект. Отражение света на поверхности металлизированной сетки достигается за счет использования сверхчистого флот-стекла, которое из-за низкого содержания оксида железа гарантирует максимальную прозрачность и высокую светопропускную способность. В результате процесса наслаивания в горячем виде полотно приобретает небольшие волнистости, которые придают материалу характерную текстуру и натуральный вид.

ЛАКИРОВАННОЕ СТЕКЛО

ECOLORSYSTEM Ecolorsystem — это название эксклюзивной коллекции лакированного стекла Rimadesio, доступной в глянцевой и матовой отделке. Коллекция характеризуется мягкими спокойными цветами, поскольку при их производстве используются только краски последнего поколения на водной основе, запекаемые при температуре 110°С. В стекольной промышленности в настоящее время внедряются современные производственные технологии, полностью роботизированные заводы, обеспечивающие высокое качество и незначительное воздействие на окружающую среду. Коррозионная стойкость соответствует требованиям положений стандарта EN ISO 9227. Устойчивость к изменениям температуры соответствует требованиям стандарта UNI 9429. Цвет характеризуется исключительной долговечностью, поскольку краски наносятся на внутреннюю поверхность стекла, защищенную от пятен, пыли и влаги. Толщина стекла создает уникальный эффект «глубины».

钢化玻璃 单片玻璃通过淬火工艺,即经 650 °C 高温烧制而成,其机械阻力相较于普通玻璃高出 5 倍。钢化玻璃破裂时会碎成不易伤人的细小碎片。符合家具玻璃安全材质 UNI EN 12150、UNI 7697 以及 UNI EN 12600 的标准。

夹层玻璃

双层玻璃。在两片玻璃之间夹有一层纤薄、透明、无形的塑料薄膜,其完全贴合两片玻璃的表面。两片玻璃的表面皆光滑无比。其抗裂性能符合 UNI EN ISO 12543、UNI 7697 以及 UNI EN 12600 的标准。玻璃破裂时,其碎片会粘在塑料薄膜上,裂而不散。

网夹层玻璃、网格夹层玻璃和纤维夹层玻璃 双层夹层玻璃。在两片超清玻璃和两层纤薄的塑料薄膜之间夹入一层微型网状物质,一道细腻的材质加工工艺,会在织物上覆盖一层金属并创造出半透明的特殊效果。使用超清浮法玻璃产出金属网表面的光线反射,因玻璃的氧化铁含量低,可确保最大透明度和高透光率。通过热分层加工工艺,夹入的织物会有不平整的现象,从而呈现出具有特色的材质纹理和自然感的外观。

环保色彩系统 (Ecolorsystem) 的烤漆玻璃 Ecolorsystem 为 Rimadesio 烤漆玻璃独家系列的名称,有亮面和哑光两种表面处理可供选择。由于仅使用最新一代的水性涂料搭配 110°C 烘烤工序完成而被称为生态环保性色彩;其为超前玻璃业界的生产技术,而全机器人化的内部设备确保极高的产品质量和低环境冲击的加工循环。其抗腐蚀程度符合 UNI EN ISO 9227 的标准。其抗温度急变性符合 UNI 9429 的标准。因色彩涂层夹于玻璃内层,因此不会褪色且不受脏污、灰尘和湿气的影响。玻璃的厚度创造出一种独特的“深度”效果。

ECOLORSYSTEM LACQUERED GLASS

GLOSSY MATT		GLOSSY MATT		GLOSSY MATT		GLOSSY MATT		GLOSSY MATT		GLOSSY MATT			
305	138 cipria	45	97 avorio	59	105 grigio chiaro	40	115 grigio cenere	53	95 bianco neve	50	108 bianco latte		
51	113 nocciola	52	107 corda	56	98 lino	312	145 grigio seta	47	96 grigio perla	78	114 sabbia		
306	139 terracotta	85	130 tufo	310	143 creta	38	121 azzurro cera	36	117 blu Londra	74	110 canapa		
76	116 rosso india	308	141 pepe	317	600 grigio artico	35	100 blu notte	39	122 verde inglese	73	109 giallo kashmir		
75	129 amaranto	309	142 sandalo	88	132 grigio scuro	86	131 blu oceano	314	147 verde lichene	43	119 laguna		
307	140 java	58	99 caffè	311	144 grigio lava	313	146 blu scuro	315	148 verde scuro	33	111 verde oliva		
		84	128 moro	46	102 nero					316	149 verde terra		

ECOLORSYSTEM METALIZED GLASS

GLOSSY MATT		SAHARA		TAIGA		DIAMANTE	
304	137 platino	504	platino sahara	804	platino taiga	404	platino diamante
69	126 palladio	569	palladio sahara	869	palladio taiga	469	palladio diamante
83	127 piombo	583	piombo sahara	883	piombo taiga	483	piombo diamante
301	134 peltro	501	peltro sahara	801	peltro taiga	401	peltro diamante
302	135 grafite	502	grafite sahara	802	grafite taiga	402	grafite diamante
303	136 bronzo	503	bronzo sahara	803	bronzo taiga	403	bronzo diamante
300	133 rame	500	rame sahara	800	rame taiga	400	rame diamante

ECOLORSYSTEM SAHARA GLASS

551	nocciola sahara	552	corda sahara	517	lino sahara	512	grigio seta sahara	514	verde lichene sahara	574	canapa sahara
506	terracotta sahara	508	pepe sahara	524	grigio artico sahara	522	blu oceano sahara	515	verde scuro sahara	543	laguna sahara
507	amaranto sahara	509	sandalo sahara	521	grigio scuro sahara	513	blu scuro sahara			523	verde oliva sahara
540	java sahara	519	caffè sahara	511	grigio lava sahara						
		584	moro sahara	546	nero sahara						

ECOLORSYSTEM TAIGA GLASS

851	nocciola taiga	852	corda taiga	817	lino taiga	812	grigio seta taiga	814	verde lichene taiga	874	canapa taiga
806	terracotta taiga	808	pepe taiga	824	grigio artico taiga	822	blu oceano taiga	815	verde scuro taiga	843	laguna taiga
807	amaranto taiga	809	sandalo taiga	821	grigio scuro taiga	813	blu scuro taiga			823	verde oliva taiga
840	java taiga	819	caffè taiga	811	grigio lava taiga						
		884	moro taiga	846	nero taiga						

NEUTRAL GLASS

55	specchio
68	specchio grigio

TRANSPARENT GLASS

890	trasparente taiga
590	trasparente sahara
490	trasparente diamante
05	trasparente extrachiaro
00	trasparente
63	grigio trasparente
65	bronzo trasparente
390	verde trasparente
391	blu trasparente

SATINATED GLASS

67	riflettente chiaro
64	riflettente grigio
81	riflettente bronzo
891	acidato taiga
591	acidato sahara
02	acidato extrachiaro
01	acidato
03	acidato grigio
04	acidato bronzo
82	nuvola extrachiaro
80	nuvola

MESH GLASS

60	rete alluminio
61	rete inox
62	rete bronzo
66	maglia gold
87	maglia rame
06	fibra argento
08	fibra bronzo



REFLEX GLASS

90	bianco reflex
92	kaki reflex
94	cacao reflex
89	nero reflex





ECOLORSYSTEM MATT LACQUERED

 305 cipria	 45 avorio	 59 grigio chiaro	 40 grigio cenere	 53 bianco neve	 16 bianco latte
 51 nocciola	 52 corda	 56 lino	 312 grigio seta	 47 grigio perla	 78 sabbia
 306 terracotta	 85 tufo	 310 creta	 38 azzurro cera	 36 blu Londra	 74 canapa
 76 rosso india	 308 pepe	 317 grigio artico	 35 blu notte	 39 verde inglese	 73 giallo kashmir
 75 amaranto	 309 sandalo	 88 grigio scuro	 86 blu oceano	 314 verde lichene	 43 laguna
 307 java	 58 caffè	 311 grigio lava	 313 blu scuro	 315 verde scuro	 33 verde oliva
	 84 moro	 13 nero			 316 verde terra

ECOLORSYSTEM LACQUERED METALIZED

 304 platino	 302 grafite
 69 palladio	 303 bronzo
 83 piombo	 300 rame
 301 petro	

ALUMINIUM

 31 alluminio lucido
 30 alluminio
 14 brown
 318 nickel grigio
 22 nero lucido

LEATHER

 C23 bianco ghiaccio
 C17 sand
 C29 toupè
 C22 caramello
 C28 fango
 C11 moka

SYNTHETIC LEATHER

 157 arena
 158 agata
 155 nube
 154 argilla
 160 miele
 153 castoro
 159 etna
 156 rubens











LUX FABRIC

 T006 gesso
 T052 segale
 T044 acciaio
 T012 marmotta
 T042 ruggine
 T051 salvia

MATERIAL FABRIC

 T020 nebbia
 T019 papiro
 T009 piuma
 T017 roccia
 T001 terracotta
 T003 brandy
 T018 tabacco









TECH FABRIC

 TT01 duna
 TT03 tortora
 TT05 mosto
 TT07 antracite
 TT09 fumo
 TT10 ghiaccio
 TT11 giada
 TT19 canyon
 TT20 dolomiti
 TT21 cedro

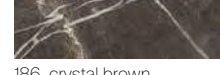
RAFIA

 T133 magnolia
 T134 desert
 T101 natural
 T115 stone
 T102 sequoia

MARBLE

 28 calacatta
 188 sierra beige
 184 crystal grey
 186 crystal brown
 180 emperador
 183 noir saint laurent
 187 verde lepanto
 182 rosso lepanto
 181 nero marquinia

MATT MARBLE

 198 calacatta opaco
 194 crystal grey opaco
 191 nero marquinia opaco
 185 crystal white opaco

LITECH

 G001 crema
 G002 moka
 G003 piedra
 G004 grigio rigato

WOOD

 711 rovere
 15 noce
 19 rovere termotrattato
 27 rovere nero
 710 tinto ebano

TAIGA WOOD

 701 rovere taiga
 700 tinto ebano taiga

SAHARA WOOD

 17 noce sahara
 20 rovere termotrattato sahara

MELAMINE

 07 melaminico olmo
 09 melaminico rovere grigio
 25 melaminico larice carbone

INTERNAL MELAMINE

 UB07 mel. cuoio grigio
 UB09 mel. cuoio brown

Collection designed by Giuseppe Bavuso.

Art direction and graphic project: Juma
Photo: Federico Cedrone, Santi Caleca
Technical photo: F2 Fotografia
Styling: Studiopepe; Patrizia Cantarella with Rossella Ballabio;
Martina Lucatelli with Martina Dalla Bona;
Simona Silenzi Studio; Gaia Marchesini and Giordano Sarno.

Thanks to: Afolki, Ames, Amini Carpets, aponteboretti, Arnolfo di Cambio, Arper, B&B Italia, Bitossi Ceramiche, Carl Hansen & Søn, Claire Lune, Egidio Milesi, Flexform, Flos, Fritz Hansen, Gröpk ceramics, Gruppo Meregalli, Henry Timi, Ittala Karakter, IWATA, Kasthall, Kenko, Knoll, Lindell & Co, Living Divani, Lorenzi Milano, Lorenzo Fransceschinis, Mario Lupo, Maru Gallery, Minotti, Mmairo, Nude Glass, Nuove Forme, Oluce, Project Audio / Audiogamma, Raawii, Rubelli, Salvatori, Scandola marmi, Secolo, Serafino Zani, Skagerak, Unurgent Argilla, Vitra, Vluv / Intentions, When Objects Work.

Artworks:
P. 152 Kazuhito Nagasawa, The place where seeds have fallen, 2012, Officine Saffi
P. 21 William Xerra, Idea di luogo, 1977

Films and print: Optima
Printed in Italy, 2024

RIMADESIO SPA
Via Furlanelli 96
20833 Giuszano (MB) Italy
T +39 0362 3171
rimadesio@rimadesio.it

MILANO FLAGSHIP STORE
Via Visconti di Modrone 26
20122 Milano Italy
T +39 02 76280708
milano@rimadesio.it

LONDON FLAGSHIP STORE
83-85, Wigmore street
1WU 1DL London
T +44 2074 862193
london@rimadesio.co.uk

NEW YORK FLAGSHIP STORE
102 Madison Ave
New York, NY 10016
T +1 917 388 2650
usa@rimadesio.us

www.rimadesio.it

AWARDS

1993	Siparium	Young & Design
2000	Zenit	Award KBB
2001	Zenit	selection Design Index ADI
2002	Siparium	Top100 Frames
2005	Graphis	selection Design Index ADI
2007	Vela	selection Design Index ADI
2008	Vela	mention XXI Premio Compasso d'Oro ADI
2015	Wind	winner Red Dot Award
2016	Cover	Best Furniture System AZ Award
2016	Alambra	selection Design Index ADI
2017	Sail	selection Design Index ADI
2017	Soho	Architectural products AZ awards
2017	Daimon	Interior Design Magazine Best of Year awards
2020	Modulor	People's Choice winner AZ Awards
2020	Modulor	Architectural Products Award of Merit AZ Awards
2020	Modulor	selection Design Index ADI
2021	Francis	selection Design Index ADI
2021	Modulor	LivingEtc Style Awards
2022	Maxi	selection Design Index ADI
2022	Aliante	finalist Interior's best of the Year awards
2022	Aliante	finalist A+Product awards
2023	Maxi	winner German Design Awards
2023	Radius	Architect's Newspaper's Best of Products Awards

PATENTED:

Air, Radius, Aliante, Rialto, Maxi, Sail, Soho, Velaria, Stripe, Daimon, Graphis, Zen, Zen frame, Siparium, Moon, Vela, Luxor, Even, Aura, Spin, Link+, Planet, Flat, Alambra, Abacus living, Self, Cover, Zenit, Dress bold, Abacus.

REGISTERED TRADEMARKS:

Rimadesio, Colorsystem, Litech, Siparium, Velaria, Abacus.



Follow us on Instagram, Facebook, LinkedIn,
WeChat, Weibo, Little Red Book.

