

SPENCER BED

DESIGN RODOLFO DORDONI



Struttura: testata unica e giroletto in legno multistrati assemblati tra loro mediante angolari in metallo che permettono un facile montaggio del letto; entrambi gli elementi sono imbottiti in poliuretano espanso ad alta resilienza a quote differenziate. Tutte le parti imbottite sono rivestite con fibra termolegata ed accoppiata con tela di cotone bianca che conferisce morbidezza e soffici ta alle imbottiture isolandole dal tessuto, garantendo in questo modo naturalezza ed igiene al prodotto.

Cuscino testata: imbottitura in fibra ipoallergenica con inserto centrale in poliuretano espanso ad alta morbidezza.

Rivestimento: in tessuto completamente sfoderabile. In pelle fisso il rivestimento della testata, sfoderabile il giroletto e il cuscino testata.

Piedini: appoggio a terra tramite piedini (disegno esclusivo Minotti Studio) stampati in alluminio pressofuso e verniciati color Peltro finitura extra-lucido anti-touch. Scivolante protettivo in Hytrel® (gomma morbida antigraffio).

N.B.:   possibile regolare l'altezza di inserimento della rete. Il supporto reggirete pu  essere agganciato al giroletto in diverse posizioni per accogliere qualsiasi tipo di rete.

Structure: multiply wood, one-piece headboard and bed frame assembled with metal brackets for easy bed assembly; both with variable-density resilient polyurethane foam padding. All the upholstered sections are covered with a fiber thermally bound to a white cotton cloth which makes the upholstery soft while separating it from the fabric, for a natural, healthy product.

Headboard cushion: padded with a hypo-allergenic fiber padding with ultra soft polyurethane foam core.

Upholstery: completely removable fabric upholstery. Non-removable leather for the headboard, removable leather covers for the bed frame and headboard cushion.

Feet: molded aluminum die-cast feet (exclusive design by Minotti Studio) with extra-glossy, anti-touch Pewter-colored finish. Protective Hytrel® glide (soft, scratch-proof rubber).

N.B.: adjustable slatted base height. The slatted base support can be fitted to the bed frame in various positions to accommodate any kind of slatted base.

Gestell: Durchgehendes Kopfteil und Rahmen aus mehrschichtigem Holz, untereinander mit Metallwinkeln verbunden, die die Montage des Betts erleichtern; beide Elemente sind mit unterschiedlich dick gesch umtem, hochdichtem Polyurethan gepolstert. Alle gepolsterten Teile sind mit Thermofaser mit wei er Baumwollabf utterung bezogen, die der Polsterung Elastizit t und Weichheit verleiht, gleichzeitig aber die Polsterung vom Bezugsstoff trennt, so dass die nat rliche Beschaffenheit und Hygiene des Produkts gewahrt werden.

Kissen des Kopfteils: mit anallergischer F llung mit zentraler Einlage aus hochweichem Polyurethanschaum.

Bezug: Stoffbezug vollst ndig abziehbar. Lederbezug am Kopfteil fest, abziehbar an Bettrahmen und Kissen.

F u e: Bodenauflage mit kleinen F u en (exklusives Design von Minotti Studio) aus Aluminiumdruckguss, zinnfarbig hochglanzlackiert mit Anti-Fingerprint-Beschichtung. Gleitschutz aus Hytrel® (weicher, kratzfester Gummi).

N.B.: Die Einlegeh he des Bettrosts kann reguliert werden. Die Rosthalterung l sst sich in verschiedenen Positionen am Rahmen einhaken, was die Verwendung von allen Rostarten erlaubt.

Structure : t te unique et cadre de lit en bois contreplaqu  assembl s par des angles de fixation en m tal permettant un montage facile du lit ; les  l ments sont tous les deux rembourr s en polyur thane expans    haute r silience,    paisseurs diff rentes. Toutes les parties rembourr es sont recouvertes de fibre thermoli e et coupl e avec de la toile de coton blanc qui donne souplesse et moelleux aux rembourrages tout en les isolant du tissu, garantissant ainsi le naturel et l'hygi ne du produit.

Coussin de la t te : rembourrage en fibre hypoallerg nique avec insert central en polyur thane expans  tr s souple.

Housse : en tissu compl tement d hous-sable. En cuir, le rev tement de la t te est fixe, celui du cadre de lit est d hous-sable ainsi que le coussin de la t te.

Pieds : appui au sol par pieds (design exclusif Minotti Studio) estamp s en aluminium moul  sous pression et peints couleur  tain, finition extra brillante anti-traces. Patins de protection en Hytrel® (caoutchouc souple anti ra-flure).

N.B. : il est possible r gler la hauteur de pose du sommier. Le support du sommier peut s'accrocher au cadre de lit en diff rentes positions pour accueillir n'importe quel type de sommier.

FINITURA PIEDINI | FEET FINISH

ALLUMINIO | ALUMINUM

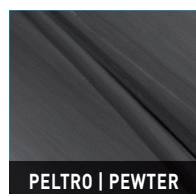

PELTRO | PEWTER

Minotti

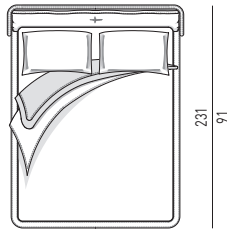
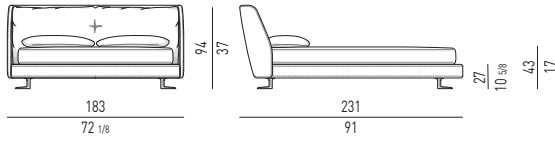

MATERASSO: 160X200 CM
MATTRESS: 63X78³/₄

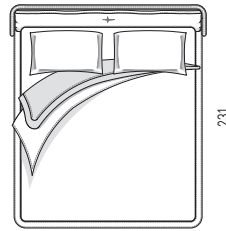
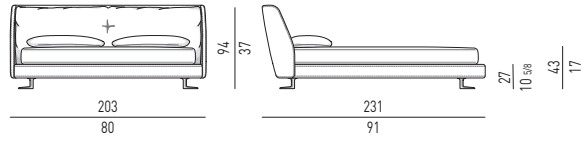

MATERASSO: 180X200 CM
MATTRESS: 70⁷/₈X78³/₄

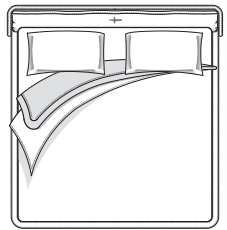
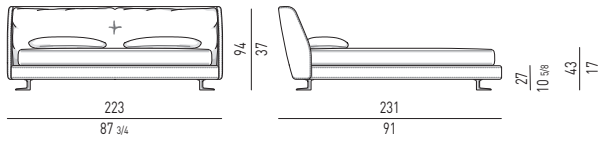

MATERASSO: 200X200 CM
MATTRESS: 78³/₄X78³/₄

QUEEN SIZE

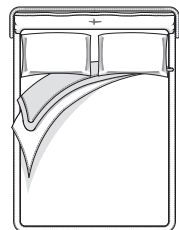
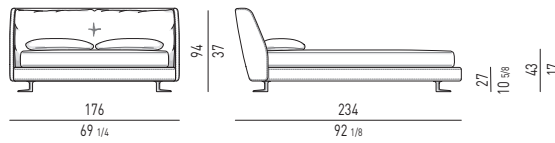

MATERASSO: 153X203 CM
MATTRESS: 60¹/₄X80

KING SIZE

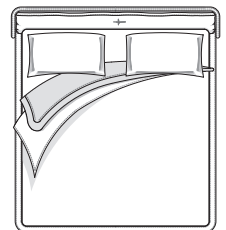
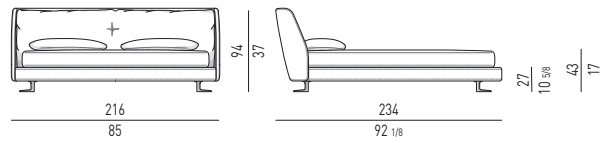

MATERASSO: 193X203 CM
MATTRESS: 76X80

CUSCINI OPTIONAL | OPTIONAL CUSHIONS

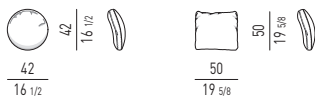

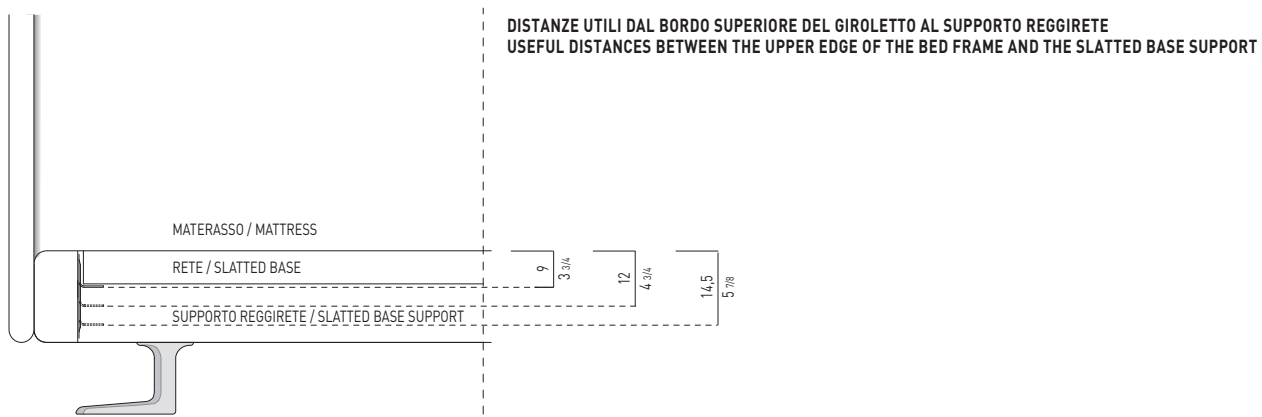

ALTEZZA DA TERRA AL BORDO SUPERIORE DEL MATERASSO | HEIGHT FROM THE GROUND TO THE HIGHER EDGE

POSIZIONE | POSITION 1

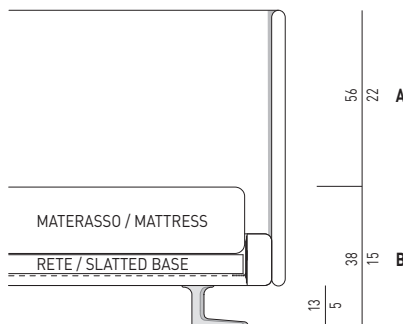

A ALTEZZA DAL MATERASSO AL BORDO SUPERIORE DELLA TESTATA LETTO.
B ALTEZZA DA TERRA AL BORDO SUPERIORE DEL MATERASSO.

POSIZIONE | POSITION 2

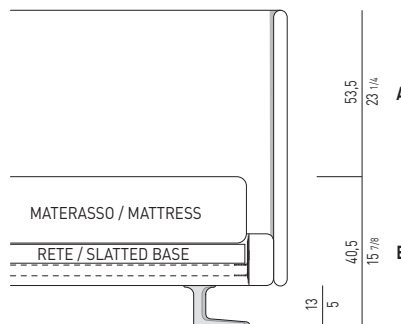

A DISTANCE FROM THE MATTRESS TO THE UPPER EDGE OF THE HEADBOARD.
B DISTANCE BETWEEN FLOOR AND UPPER EDGE OF MATTRESS.

POSIZIONE | POSITION 3

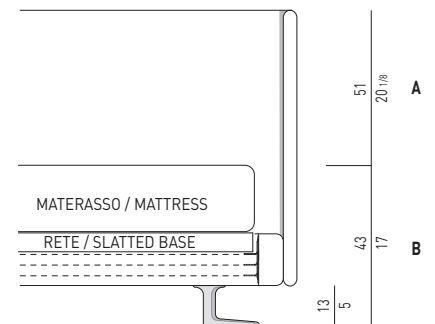

A HAUTER DU MATELAS AU BORD SUPERIEUR DE LA TÊTE DE LIT.
B HAUTEUR DU BORD SUPERIEUR DU MATELAS PAR RAPPORT AU SOL.

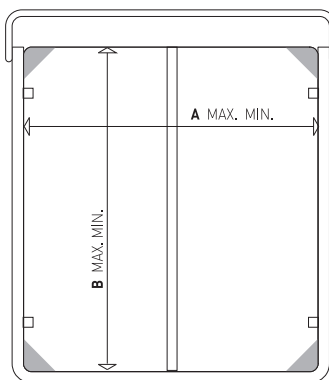

INGOMBRO RETE FISSA MATRIMONIALE PER LETTO CM 183X231 / OVERALL DIMENSIONS OF FIXED DOUBLE SLATTED BASE FOR BED SIZE CM 183X231

A DISTANZA UTILE MAX. CM 160, MIN. CM 158 PER APPOGGIO RETE / MAX. CM 160, MIN. CM 158 USEFUL DISTANCES FOR ACCOMMODATING THE BASE.
B DISTANZA UTILE MAX. CM 200, MIN. CM 198 PER APPOGGIO RETE / MAX. CM 200, MIN. CM 198 USEFUL DISTANCES FOR ACCOMMODATING THE BASE.

INGOMBRO RETE FISSA MATRIMONIALE PER LETTO CM 203X231 / OVERALL DIMENSIONS OF FIXED DOUBLE SLATTED BASE FOR BED SIZE CM 203X231

A DISTANZA UTILE MAX. CM 180, MIN. CM 178 PER APPOGGIO RETE / MAX. CM 180, MIN. CM 178 USEFUL DISTANCES FOR ACCOMMODATING THE BASE.
B DISTANZA UTILE MAX. CM 200, MIN. CM 198 PER APPOGGIO RETE / MAX. CM 200, MIN. CM 198 USEFUL DISTANCES FOR ACCOMMODATING THE BASE.

INGOMBRO RETE FISSA MATRIMONIALE PER LETTO CM 223X231 / OVERALL DIMENSIONS OF FIXED DOUBLE SLATTED BASE FOR BED SIZE CM 223X231

A DISTANZA UTILE MAX. CM 200, MIN. CM 198 PER APPOGGIO RETE / MAX. CM 200, MIN. CM 198 USEFUL DISTANCES FOR ACCOMMODATING THE BASE.
B DISTANZA UTILE MAX. CM 200, MIN. CM 198 PER APPOGGIO RETE / MAX. CM 200, MIN. CM 198 USEFUL DISTANCES FOR ACCOMMODATING THE BASE.

INGOMBRO RETE FISSA MATRIMONIALE PER LETTO CM 176X234 / OVERALL DIMENSIONS OF FIXED DOUBLE SLATTED BASE FOR BED SIZE CM 176X234

A DISTANZA UTILE MAX. CM 153, MIN. CM 151 PER APPOGGIO RETE / MAX. CM 153, MIN. CM 151 USEFUL DISTANCES FOR ACCOMMODATING THE BASE.
B DISTANZA UTILE MAX. CM 203, MIN. CM 201 PER APPOGGIO RETE / MAX. CM 203, MIN. CM 201 USEFUL DISTANCES FOR ACCOMMODATING THE BASE.

INGOMBRO RETE FISSA MATRIMONIALE PER LETTO CM 216X234 / OVERALL DIMENSIONS OF FIXED DOUBLE SLATTED BASE FOR BED SIZE CM 216X234

A DISTANZA UTILE MAX. CM 193, MIN. CM 191 PER APPOGGIO RETE / MAX. CM 193, MIN. CM 191 USEFUL DISTANCES FOR ACCOMMODATING THE BASE.
B DISTANZA UTILE MAX. CM 203, MIN. CM 201 PER APPOGGIO RETE / MAX. CM 203, MIN. CM 201 USEFUL DISTANCES FOR ACCOMMODATING THE BASE.

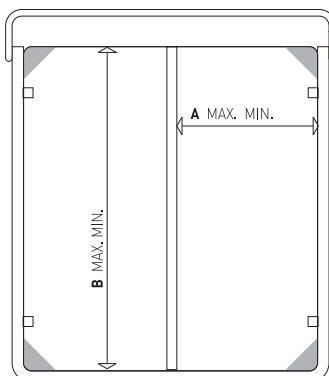

INGOMBRO RETI SINGOLE PER LETTO CM 183X231 / OVERALL DIMENSIONS OF SINGLE BASES FOR BED SIZE CM 183X231

A DISTANZA UTILE MAX. CM 80, MIN. CM 77 PER APPOGGIO RETE / MAX. CM 80, MIN. CM 77 USEFUL DISTANCES FOR ACCOMMODATING THE BASE.
B DISTANZA UTILE MAX. CM 200, MIN. CM 198 PER APPOGGIO RETE / MAX. CM 200, MIN. CM 198 USEFUL DISTANCES FOR ACCOMMODATING THE BASE.

INGOMBRO RETI SINGOLE PER LETTO CM 203X231 / OVERALL DIMENSIONS OF SINGLE BASES FOR BED SIZE CM 203X231

A DISTANZA UTILE MAX. CM 90, MIN. CM 87 PER APPOGGIO RETE / MAX. CM 90, MIN. CM 87 USEFUL DISTANCES FOR ACCOMMODATING THE BASE.
B DISTANZA UTILE MAX. CM 200, MIN. CM 198 PER APPOGGIO RETE / MAX. CM 200, MIN. CM 198 USEFUL DISTANCES FOR ACCOMMODATING THE BASE.

INGOMBRO RETI SINGOLE PER LETTO CM 223X231 / OVERALL DIMENSIONS OF SINGLE BASES FOR BED SIZE CM 223X231

A DISTANZA UTILE MAX. CM 100, MIN. CM 97 PER APPOGGIO RETE / MAX. CM 100, MIN. CM 97 USEFUL DISTANCES FOR ACCOMMODATING THE BASE.
B DISTANZA UTILE MAX. CM 200, MIN. CM 198 PER APPOGGIO RETE / MAX. CM 200, MIN. CM 198 USEFUL DISTANCES FOR ACCOMMODATING THE BASE.