

SAIL

Rimadesio



SAIL COMBINES HIGH TECHNICAL AND FUNCTIONAL PERFORMANCE WITH AN ORIGINAL AESTHETIC AND A STRONG EXPRESSIVE VALUE. RESULT OF A CAREFUL TECHNOLOGICAL RESEARCH AND OF AN ELABORATE MANUAL ASSEMBLING WORK OF THE COMPONENTS, SAIL BECOMES A REAL DECORATIVE ITEM. ENDLESS COMBINING SOLUTIONS BETWEEN THE RIMADESIO GLASS FINISHINGS AND THE ALUMINIUM STRUCTURAL ELEMENT, ALSO AVAILABLE IN NOCE OR ROVERE TERMOTRATTATO VENEERED VERSION.

IT Sail associa alte prestazioni tecniche e funzionali a un'estetica originale e dal forte valore espressivo. Risultato di un'attenta ricerca tecnologica e di un complesso lavoro manuale nell'assemblaggio dei componenti, Sail si propone come un vero e proprio elemento d'arredo. Infinite le soluzioni di abbinamento tra le finiture dei vetri Rimadesio e l'alluminio degli elementi strutturali, disponibili anche nella versione rivestita in noce o rovere termotrattato.

DE Sail kombiniert hohe technische und funktionale Lösungen mit einer einzigartigen Ästhetik und einem starken Ausdruckswert. Nach sorgfältiger technologischer Recherche und aufwändiger Handarbeit bei der Montage der Komponenten präsentiert sich Sail als echtes Einrichtungselement. Sail bietet unendlich passende Lösungen mit den Rimadesio Glasoberflächen und den Aluminiumstrukturelementen. Sail ist auch in einer Version verkleidet mit Noce oder Rovere termotrattato erhältlich.

FR Sail associe des performances techniques et fonctionnelles à une esthétique originale et une forte valeur expressive. Fruit d'une recherche technologique minutieuse et d'un travail manuel complexe dans l'assemblage des composants, Sail se présente comme un véritable élément d'ameublement. Des solutions infinies de combinaisons entre les finitions des verres Rimadesio et l'aluminium des éléments structurels, disponibles aussi dans la version revêtue en noce et rovere termotrattato.

ES Sail combina un alto rendimiento técnico y funcional con una estética original y un fuerte valor expresivo. Resultado de una cuidadosa investigación tecnológica y de un complejo trabajo manual en el ensamblaje de los componentes, Sail se presenta como un elemento de mobiliario real. Infinitas soluciones de combinación entre los acabados de vidrio Rimadesio y el aluminio de los elementos estructurales, también disponibles en una versión en noce o rovere termotrattato.

RU Двери Sail представляют собой сочетание высоких технических и функциональных характеристик с оригинальным и привлекательным внешним видом. Двери Sail - это результат тщательных технологических исследований и сложной ручной работы по сборке компонентов. Предлагается использовать их в качестве настоящего элемента интерьера. Существует бесчисленное множество решений по сочетанию отделки стекла Rimadesio с алюминиевыми элементами конструкции, которые также могут быть выполнены с покрытием из ореха или термообработанного дуба.

汉语 Sail 集高技术、高性能、原创美感和鲜明表现力于一身。Sail 历经严谨的技术研究，再以繁复手工的部件组装，成为一项正式的家饰设计元素。Rimadesio 提供各式各样的玻璃饰面与铝质结构件，互相搭配饰面无数种组合方案，另有胡桃木、橡木和热处理橡木等多种木材可供选择。



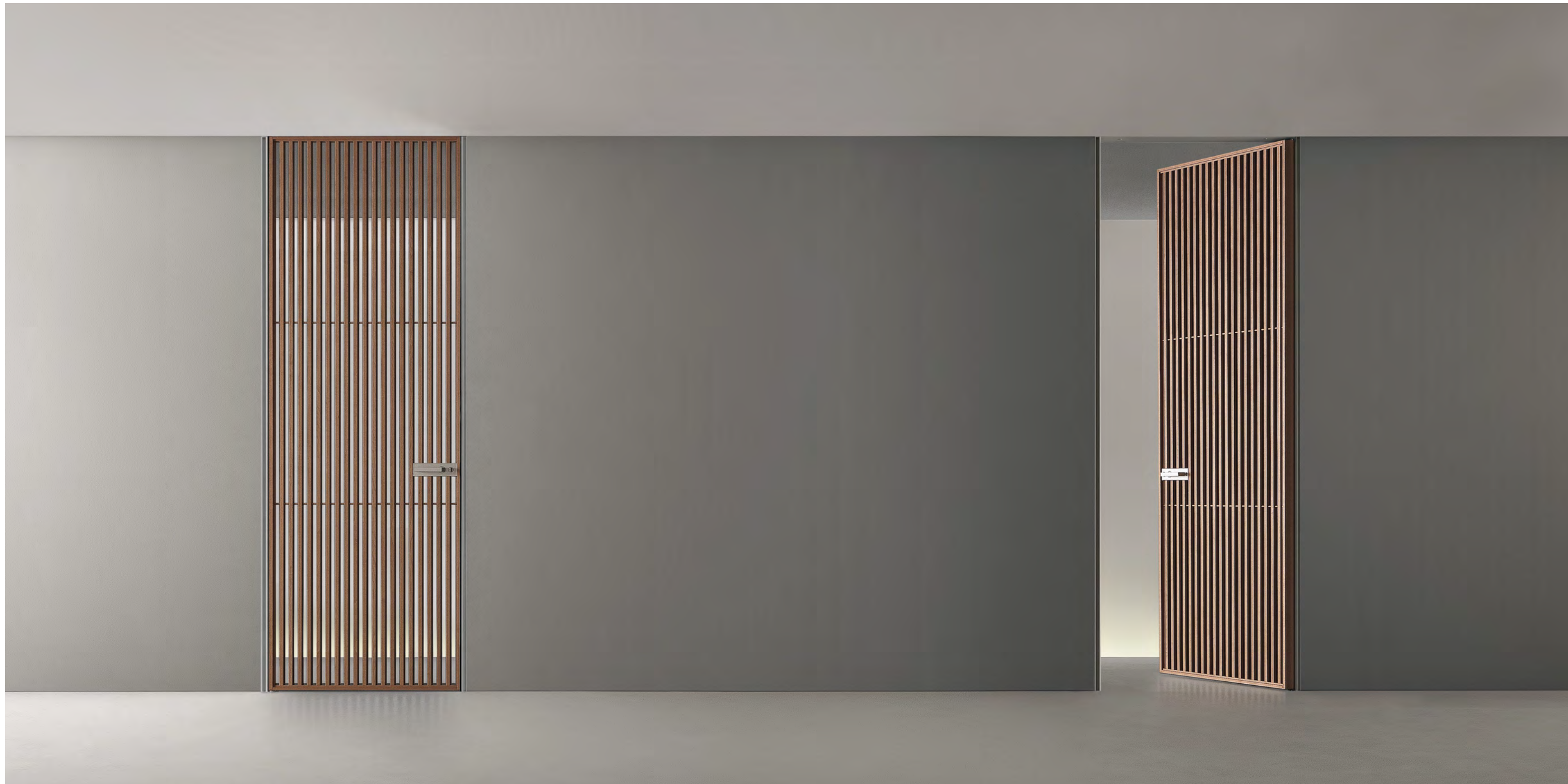

DOOR WITH PULL OPENING

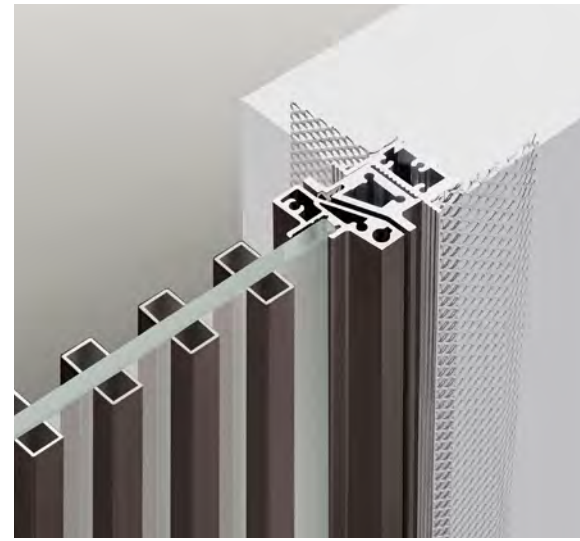

Right

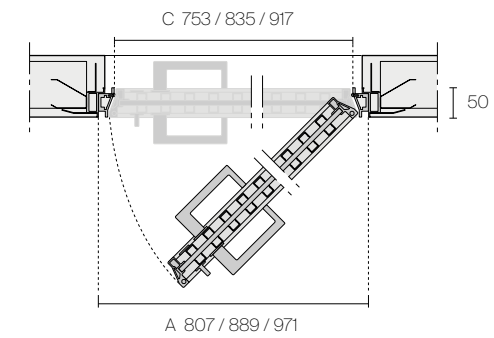

Left

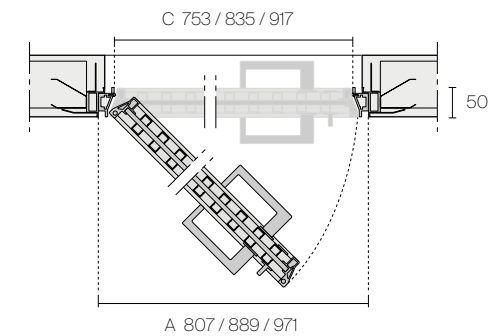

Wall flush swing door

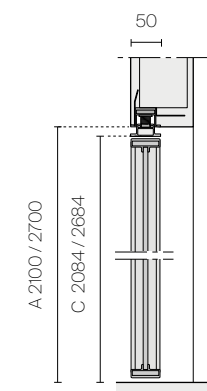

DOOR WITH PUSH OPENING

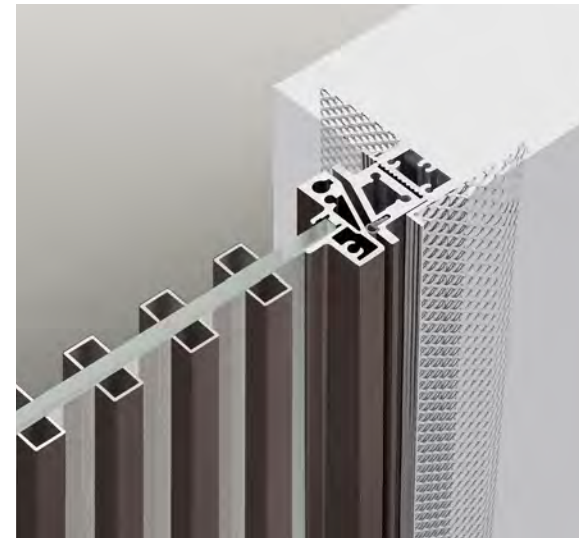

Right

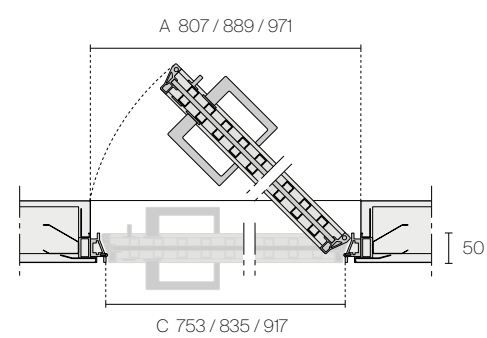

Left

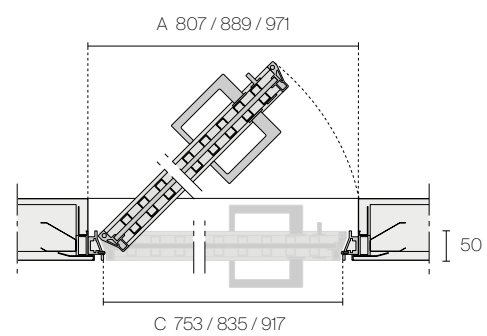

Ceiling flush swing door

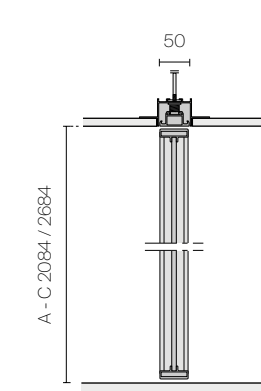

POCKET DOOR FOR SYSTEMS  
SCRIGNO® ESSENTIAL, ECLISSE® SYNTESIS® LINE

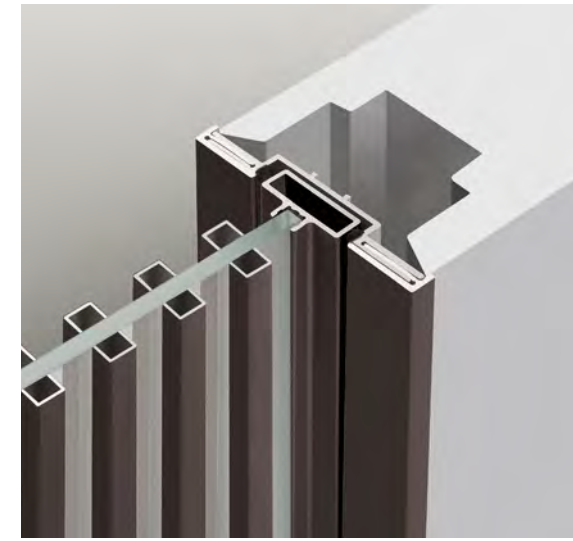

The swing door version is available in standard dimensions or can be custom made, with a maximum height of 2700 mm. In the pocket version, always custom made in height up to 2700 mm, the telescopic mini jamb is provided with snap-fit closure without visible screws or joints

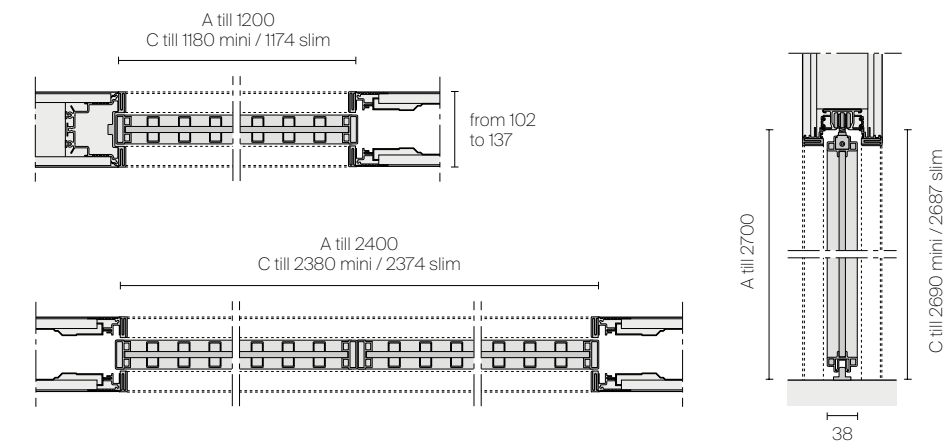

A. Subframe dimensions  
C. Opening dimensions

TECHNICAL DESCRIPTION

EN Sail flush doors can be opened by pushing or pulling, offering the maximum customizable design. The "s" shaped profile eliminates the rebate in the coupling between panel and jamb. The aluminium subframe allows for perfect installation both on brick and plasterboard walls.

IT Le porte coplanari Sail consentono la possibilità di apertura a spingere o a tirare, garantendo la massima libertà progettuale. Il profilo a "s" elimina la battuta nell'accoppiamento tra pannello e stipite. Il falso telaio interamente in alluminio garantisce una perfetta installazione della porta su parete in muratura e su cartongesso.

DE Die Drehtüren Sail können entweder zum "drücken" oder "ziehen" geöffnet werden. Das S-förmige Profil charakterisiert die Tür Zen, und eliminiert den Übergang in der Befestigung zwischen Türblatt Rahmen. Die Tür ist sowohl in Standarddimensionen als auch in Sondermaßen erhältlich. Der Blindstock aus Aluminium garantiert eine perfekte Montage bei Ziegelwänden sowie Gipskarton.

FR Les portes coplanaires Sail permettent la possibilité d'ouverture en poussant ou en tirant, assurant un maximum de liberté dans le projet. Caractérisé par le profil à "s", qui ne nécessite pas de retour de jamba sur le mur. Le faux châssis en aluminium garantit une parfaite installation de la porte sur le mur en brique et de placo-plâtre.

ES Las puertas coplanares Sail permiten la posibilidad de abrir empujando o tirando, que garantiza la máxima libertad de diseño. Caracterizada por el perfil a "S" que elimina la golpe en la union entre el panel y la jamba. El premarco enteramente en aluminio garantiza una perfecta instalación de la puerta en el muro de ladrillo o pladur.

RU Копланарные двери Sail могут открываться от себя или на себя, обеспечивая максимальную свободу дизайна. Благодаря s-образному профилю коробки отпадает необходимость в притворе для соединения между панелью и откосом. Фальш-короб, полностью из алюминия, обеспечивает идеальный монтаж двери в кирпичную и гипсокартонную стену.

汉语 Sail 的多款齐平门可做推式或拉式, 提供极高的设计灵活性。采用 S 型型材, 免除门板和门套之间连接处的边缘型材。采用纯铝合金制的副门框, 确保在砖石墙和石膏板隔墙上都能美安装。

DIMENSIONS

Swing door

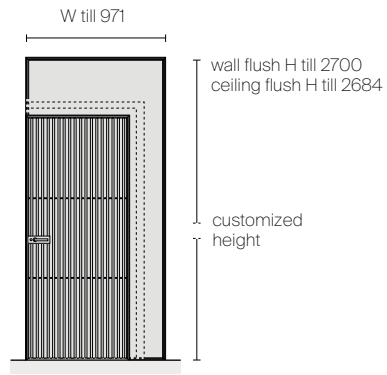

HANDLES



1. Handle TR07C with key
2. Handle TR07 with lever tumbler
3. Handle 2015

FINISHINGS

Structure for swing door

ALUMINIUM



WOOD

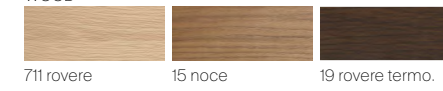

Handle for swing door

ALUMINIUM

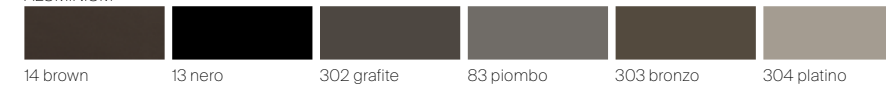

Structure for pocket door

ALUMINIUM



WOOD

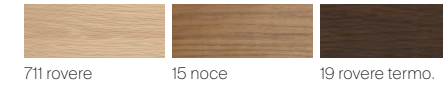

Handle for pocket door

ALUMINIUM



WOOD

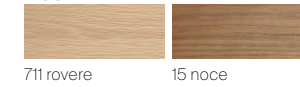

Door panel

LACQUERED GLASS



METALIZED GLASS



REFLEX GLASS

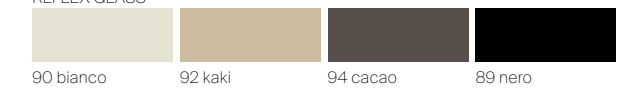

MESH GLASS



TRANSPARENT GLASS

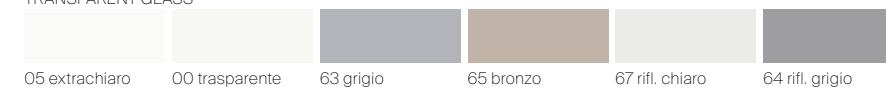

SATINATED GLASS

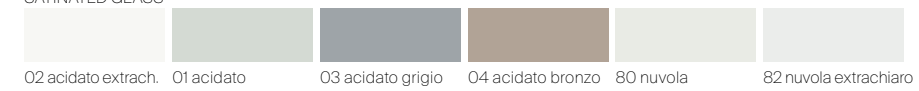

NEUTRAL GLASS

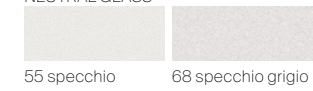

QUALITY AS THE MAIN PURPOSE, ALWAYS AND IN EVERY ASPECT. WITH THIS MISSION RIMADESIO IS CONSTANTLY SEARCHING FOR SOLUTIONS TO IMPROVE ITS OWN ECOLOGICAL STANDARDS.

OBJECTIVE OBTAINED THANKS TO THE USE OF PRECIOUS AND RECYCLABLE MATERIALS, TO THE ABSENCE OF SUBSTANCES THAT CAN BE TOXIC TO HUMANS OR HARMFUL TO THE ENVIRONMENT IN EVERY PHASE OF THE PRODUCTIVE PROCESS, TO THE USE OF TECHNOLOGY AND EVOLVED MACHINERY, POWERED BY CLEAN ENERGY DERIVED FROM PHOTOVOLTAIC SYSTEMS, INSTALLED ON THE GIUSSANO HEADQUARTERS ROOF.

ALUMINIUM, GLASS, WOOD: FULLY RECYCLABLE AND PARTLY ALREADY RECYCLED MATERIALS.

PROOFS OF A REINFORCED GREEN DNA AND WIDE COHERENCE, SIGNALS OF A CONTINUOUS RESEARCH AND A GLANCE TOWARDS THE FUTURE, THAT TAKES SHAPE IN THE TECHNOLOGICAL INNOVATION OF SYSTEMS, DOORS AND FURNITURE, MADE WITH THE AWARENESS OF WANTING TO ENTRUST HUMANS ONLY WITH HIGH VALUE-ADDED ACTIVITIES.

# EXCELLENCE SUSTAINABILITY PROJECT

IT Perseguire la qualità, sempre, sotto tutti gli aspetti. Con questa mission Rimadesio ricerca costantemente soluzioni volte a migliorare i propri standard qualitativi ecologici. Obiettivo ottenuto sinergicamente, grazie all'utilizzo di materiali preziosi e riciclabili, all'assenza di sostanze tossiche per l'uomo e nocive per l'ambiente in ogni fase del processo produttivo, all'impiego di tecnologie e macchinari evoluti alimentati con energia pulita proveniente da impianti fotovoltaici, installati sulla copertura dell'headquarter di Giussano. Alluminio, vetro, legno, materiali totalmente riciclabili e in parte già riciclati, ma anche le vernici prive di solventi di Ecoloursystem e i sistemi di imballaggio ecologici. Testimonianze di un dna green consolidato e di una coerenza trasversale, segnali di una continua attività di ricerca e di uno sguardo sempre proteso al futuro che si declina nell'innovazione tecnologica di sistemi, porte ed arredi, realizzati con la consapevolezza di voler affidare all'uomo solo attività dall'alto valore aggiunto.

DE Stets um Qualität bemüht, und zwar in allen Bereichen. Mit dieser Mission im Blick sucht Rimadesio laufend nach Lösungen, um seine ökologischen Qualitätsstandards zu verbessern. Dieses Ziel wurde dank der Verwendung wertvoller und wiederverwertbarer Materialien, dem Verzicht auf für den Menschen giftige und umweltschädliche Stoffe in jeder Phase des Produktionsprozesses und dem Einsatz fortschrittlicher Technologien und Maschinen, die mit sauberer Energie aus den auf dem Dach des Giussano-Hauptsitzes installierten Photovoltaikanlagen betrieben werden, synergetisch erreicht. Aluminium, Glas, Holz, vollständig recycelbare und teilweise bereits recycelte Materialien, aber auch die lösungsmittelfreien Farben von Ecoloursystem und umweltfreundliche Verpackungssysteme. Ein Zeugnis einer fundierten grünen DNA und einer transversalen Kohärenz, Zeichen einer kontinuierlichen Forschungstätigkeit und eines stets in die Zukunft gerichteten Blicks, der sich in der technologischen Innovation von Systemen, Türen und Einrichtungsgegenständen ausdrückt, die in dem Bewusstsein realisiert werden, den Menschen nur Tätigkeiten mit hohem Mehrwert anzuvertrauen.

FR Poursuivre la qualité, toujours, et à tous les égards. Avec cette mission Rimadesio recherche constamment de solutions au fin d'améliorer ses normes de qualité écologique. Objectif atteint, grâce à l'utilisation de matériaux précieux et recyclables, l'absence à chaque étape de la production de substances toxiques nocives pour l'homme et l'environnement, l'utilisation de technologies et des machines avancées alimentées par l'énergie solaire après l'installation sur le toit de l'usine à Giussano de systèmes photovoltaïques. Aluminium, verre, bois, des matériaux entièrement recyclables et déjà en partie recyclés, mais aussi peinture Ecoloursystem sans solvants et systèmes d'emballage respectueux de l'environnement. Témoignages d'un adn "vert" consolidé et d'une cohérence transversale, signes de recherche continue et d'une tendance à regarder en avant, qui correspond bien à l'innovation technologique des systèmes, des portes et des meubles, réalisés avec la conscience que l'apport de l'homme dans la production ne peut qu'avoir un valeur ajoutée.

ES Perseguir la calidad, siempre, en todos los aspectos. Con esta misión Rimadesio busca constantemente soluciones destinadas a mejorar sus estándares de calidad ecológica. Objetivo conseguido sinérgicamente, gracias al uso de materiales preciosos y reciclables, a la ausencia de sustancias tóxicas para los seres humanos y nocivas para el medio ambiente en cada etapa del proceso de producción, al uso de tecnologías y máquinas avanzadas alimentadas por energía limpia a partir de sistemas fotovoltaicos, instalados en la cobertura del headquarter de Giussano. Aluminio, cristal, madera, materiales completamente reciclables y, en parte, ya reciclados, sino también las pinturas Ecoloursystem libres de disolventes y los sistemas de embalaje ecológicos. Testimonios de un adn green consolidado y una coherencia transversal, señales de una continua investigación y de una vista siempre tendida al futuro que se declina en la innovación tecnológica de sistemas, puertas y muebles, realizados con el conocimiento que desea confiar al hombre sólo actividades de alto valor añadido.

RU Обеспечение качества всегда и во всем. И, в том числе, для достижения этой цели Компания Rimadesio находится в постоянном поиске решений, направленных на улучшение экологических стандартов качества. Эта цель была достигнута благодаря использованию на каждом этапе производственного процесса ценных материалов, пригодных для вторичной переработки, отсутствию токсичных для человека и вредных для окружающей среды веществ, а также благодаря внедрению передовых технологий и оборудования, работающего на чистой энергии от фотоэлектрических систем, установленных на крыше штаб-квартиры компании в г. Джуссано. Компания использует такие материалы, как алюминий, стекло, дерево – полностью перерабатываемые и уже частично переработанные материалы, краски Ecoloursystem, не содержащие растворителей, а также экологически упаковку. Свидетельство консолидированной экологичности и непрерывной последовательности, исследовательской деятельности и взгляда, всегда устремленного в будущее, что выражается в технологических инновациях систем, дверей и мебели, произведенных с осознанием того, что человеку стоит поручать только деятельность с высокой добавленной стоимостью.

汉语 始终至终追求全方位的卓越品质。Rimadesio 肩负使命，不断探索精进生态质量标准的解决方案。品牌目标之达成有赖于珍贵的可回收材料，该材料在所有制造阶段皆不会产生危害人体和环境之有毒物质，同时结合业界前沿的技术以及先进机械装置；而位于朱塞诺 (Giussano) 品牌总部建筑屋顶上的光伏发电设备为上述之机械装置供给干净的能源。除了可完全回收和已部分回收的铝材、玻璃、木材等材料之外，还有环保色彩系统 (Ecoloursystem) 的无溶剂涂料和生态环保型包装。深植的绿色 DNA、跨领域的协同性、持续的研究工作以及具前瞻性的未来展望皆体现在家具系统、各式门类 and 家具配件的技术创新上，其本着信赖人类才能胜任高附加价值活动的意念研发而成。





ECOLORSYSTEM LACQUERED GLASS

GLOSSY MATT		GLOSSY MATT		GLOSSY MATT		GLOSSY MATT		GLOSSY MATT		GLOSSY MATT			
305	138 cipria	45	97 avorio	59	105 grigio chiaro	40	115 grigio cenere	53	95 bianco neve	50	108 bianco latte		
51	113 nocciola	52	107 corda	56	98 lino	312	145 grigio seta	47	96 grigio perla	78	114 sabbia		
306	139 terracotta	85	130 tufo	310	143 creta	38	121 azzurro cera	36	117 blu Londra	74	110 canapa		
76	116 rosso india	308	141 pepe	317	600 grigio artico	35	100 blu notte	39	122 verde inglese	73	109 giallo kashmir		
75	129 amaranto	309	142 sandalo	88	132 grigio scuro	86	131 blu oceano	314	147 verde lichene	43	119 laguna		
307	140 java	58	99 caffè	311	144 grigio lava	313	146 blu scuro	315	148 verde scuro	33	111 verde oliva		
		84	128 moro	46	102 nero					316	149 verde terra		

ECOLORSYSTEM SAHARA GLASS

551	nocciola sahara	552	corda sahara	517	lino sahara	512	grigio seta sahara	514	verde lichene sahara	574	canapa sahara
506	terracotta sahara	508	pepe sahara	524	grigio artico sahara	522	blu oceano sahara	515	verde scuro sahara	543	laguna sahara
507	amaranto sahara	509	sandalo sahara	521	grigio scuro sahara	513	blu scuro sahara			523	verde oliva sahara
540	java sahara	519	caffè sahara	511	grigio lava sahara						
		584	moro sahara	546	nero sahara						

ECOLORSYSTEM TAIGA GLASS

851	nocciola taiga	852	corda taiga	817	lino taiga	812	grigio seta taiga	814	verde lichene taiga	874	canapa taiga
806	terracotta taiga	808	pepe taiga	824	grigio artico taiga	822	blu oceano taiga	815	verde scuro taiga	843	laguna taiga
807	amaranto taiga	809	sandalo taiga	821	grigio scuro taiga	813	blu scuro taiga			823	verde oliva taiga
840	java taiga	819	caffè taiga	811	grigio lava taiga						
		884	moro taiga	846	nero taiga						

ECOLORSYSTEM METALIZED GLASS

GLOSSY MATT		SAHARA		TAIGA		DIAMANTE	
304	137 platino	504	platino sahara	804	platino taiga	404	platino diamante
69	126 palladio	569	palladio sahara	869	palladio taiga	469	palladio diamante
83	127 piombo	583	piombo sahara	883	piombo taiga	483	piombo diamante
301	134 peltro	501	peltro sahara	801	peltro taiga	401	peltro diamante
302	135 grafite	502	grafite sahara	802	grafite taiga	402	grafite diamante
303	136 bronzo	503	bronzo sahara	803	bronzo taiga	403	bronzo diamante
300	133 rame	500	rame sahara	800	rame taiga	400	rame diamante

NEUTRAL GLASS

55	specchio
68	specchio grigio

TRANSPARENT GLASS

890	trasparente taiga
590	trasparente sahara
490	trasparente diamante
05	trasparente extrachiaro
00	trasparente
63	grigio trasparente
65	bronzo trasparente
390	verde trasparente
391	blu trasparente

SATINATED GLASS

67	riflettente chiaro
64	riflettente grigio
81	riflettente bronzo
891	acidato taiga
591	acidato sahara
02	acidato extrachiaro
01	acidato
03	acidato grigio
04	acidato bronzo
82	nuvola extrachiaro
80	nuvola

MESH GLASS

60	rete alluminio
61	rete inox
62	rete bronzo
66	maglia gold
87	maglia rame
06	fibra argento
08	fibra bronzo

REFLEX GLASS





90	bianco reflex
92	kaki reflex
94	cacao reflex
89	nero reflex







ECOLORSYSTEM MATT LACQUERED

 305 cipria	 45 avorio	 59 grigio chiaro	 40 grigio cenere	 53 bianco neve	 16 bianco latte
 51 nocciola	 52 corda	 56 lino	 312 grigio seta	 47 grigio perla	 78 sabbia
 306 terracotta	 85 tufo	 310 creta	 38 azzurro cera	 36 blu Londra	 74 canapa
 76 rosso india	 308 pepe	 317 grigio artico	 35 blu notte	 39 verde inglese	 73 giallo kashmir
 75 amaranto	 309 sandalo	 88 grigio scuro	 86 blu oceano	 314 verde lichene	 43 laguna
 307 java	 58 caffè	 311 grigio lava	 313 blu scuro	 315 verde scuro	 33 verde oliva
	 84 moro	 13 nero			 316 verde terra

ECOLORSYSTEM LACQUERED METALIZED

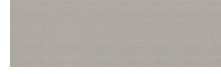
 304 platino	 302 grafite
 69 palladio	 303 bronzo
 83 piombo	 300 rame
 301 petro	

ALUMINIUM

 31 alluminio lucido
 30 alluminio
 14 brown
 318 nickel grigio
 22 nero lucido

LEATHER

 C23 bianco ghiaccio
 C17 sand
 C29 toupè
 C22 caramello
 C28 fango
 C11 moka

SYNTHETIC LEATHER

 157 arena
 158 agata
 155 nube
 154 argilla
 160 miele
 153 castoro
 159 etna
 156 rubens









LUX FABRIC

 T006 gesso
 T052 segale
 T044 acciaio
 T012 marmotta
 T042 ruggine
 T051 salvia

MATERIAL FABRIC

 T020 nebbia
 T019 papiro
 T009 piuma
 T017 roccia
 T001 terracotta
 T003 brandy
 T018 tabacco

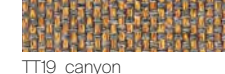







TECH FABRIC

 TT01 duna
 TT03 tortora
 TT05 mosto
 TT07 antracite
 TT09 fumo
 TT10 ghiaccio
 TT11 giada
 TT19 canyon
 TT20 dolomiti
 TT21 cedro

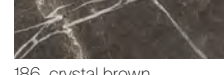
RAFIA

 T133 magnolia
 T134 desert
 T101 natural
 T115 stone
 T102 sequoia

MARBLE

 28 calacatta
 188 sierra beige
 184 crystal grey
 186 crystal brown
 180 emperador
 183 noir saint laurent
 187 verde lepanto
 182 rosso lepanto
 181 nero marquinia



MATT MARBLE

 198 calacatta opaco
 194 crystal grey opaco
 191 nero marquinia opaco
 185 crystal white opaco

LITECH

 G001 crema
 G002 moka
 G003 pietra
 G004 grigio rigato

WOOD

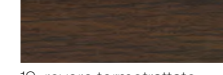
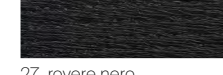
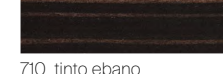
 711 rovere
 15 noce
 19 rovere termotrattato
 27 rovere nero
 710 tinto ebano

TAIGA WOOD

 701 rovere taiga
 700 tinto ebano taiga

SAHARA WOOD

 17 noce sahara
 20 rovere termotrattato sahara

MELAMINE

 07 melaminico olmo
 09 melaminico rovere grigio
 25 melaminico larice carbone

INTERNAL MELAMINE

 UB07 mel. cuoio grigio
 UB09 mel. cuoio brown

Collection designed by Giuseppe Bavuso.

Art direction and graphic project: Juma  
Photo: Federico Cedrone, Santi Caleca  
Technical photo: F2 Fotografia  
Styling: Studiopepe; Patrizia Cantarella with Rossella Ballabio;  
Martina Lucatelli with Martina Dalla Bona;  
Simona Silenzi Studio; Gaia Marchesini and Giordano Sarno.

Thanks to: Afolki, Agape, Ames, Amini Carpets, aponteboretti, Arnolfo di Cambio, Artemide, Astep, AYTM, Azucena, B&B Italia, Baxter, Bitossi Ceramiche, Brionvega, Carl Hansen & Søn, Claire Lune, Cooeee Design, Danese Milano, Dany GILLES, Davide Groppi, De Vecchi Milano 1935, Dechem Studio, Dep Art Gallery, Egidio Milesi, Emil, Etel Milano, Flexform, Flos, FontanaArte, FPM Milano, Fritz Hansen, Gan Rugs, Gardeco, Gervasoni 1882, Henry Timi, Ittala, Ivano Redaelli, Iwata Mokku, J. & L. Lobmeyr, Knoll, Lanerossi, Lindell & Co, Living Divani, Lorenzo Franceschinis, Louis Poulsen, Maru Gallery, Matteo Thun Atelier, distributed by Manus Factor, Maxalto, Nemo Lighting, Noorstad, Noorth, Nude Glass, NUMA Limited Editions, Nuove Forme, Officine Saffi, Oluce, Pallucco, Phantom Hands, Raawi, Rains, Raumgestalt, Riva 1920, Scandola marmi, Serafino Zani, Skagerak, Society, STELTON distribuito da Schönhuber Spa, Suede, Tacchini, Terry Davies Ceramics, Unurgent Argilla, Up To You Anthology, Vitra, When Objects Work.

Films and print: Optima  
Printed in Italy, 2024

RIMADESIO SPA  
Via Furlanelli 96  
20833 Giuszano (MB) Italy  
T +39 0362 3171  
rimadesio@rimadesio.it

MILANO FLAGSHIP STORE  
Via Visconti di Modrone 26  
20122 Milano Italy  
T +39 02 76280708  
milano@rimadesio.it

LONDON FLAGSHIP STORE  
83-85, Wigmore street  
1WU 1DL London  
T +44 2074 862193  
london@rimadesio.co.uk

NEW YORK FLAGSHIP STORE  
102 Madison Ave  
New York, NY 10016  
T +1 917 388 2650  
usa@rimadesio.us

[www.rimadesio.it](http://www.rimadesio.it)

#### AWARDS

1993	Siparium	Young & Design
2000	Zenit	Award KBB
2001	Zenit	selection Design Index ADI
2002	Siparium	Top100 Frames
2005	Graphis	selection Design Index ADI
2007	Vela	selection Design Index ADI
2008	Vela	mention XXI Premio Compasso d'Oro ADI
2015	Wind	winner Red Dot Award
2016	Cover	Best Furniture System AZ Award
2016	Alambra	selection Design Index ADI
2017	Sail	selection Design Index ADI
2017	Soho	Architectural products AZ awards
2017	Daimon	Interior Design Magazine Best of Year awards
2020	Modulor	People's Choice winner AZ Awards
2020	Modulor	Architectural Products Award of Merit AZ Awards
2020	Modulor	selection Design Index ADI
2021	Francis	selection Design Index ADI
2021	Modulor	LivingEtc Style Awards
2022	Maxi	selection Design Index ADI
2022	Aliante	finalist Interior's best of the Year awards
2022	Aliante	finalist A+Product awards
2023	Maxi	winner German Design Awards
2023	Radius	Architect's Newspaper's Best of Products Awards

#### PATENTED:

Air, Radius, Aliante, Rialto, Maxi, Sail, Soho, Velaria, Stripe, Daimon, Graphis, Zen, Zen frame, Siparium, Moon, Vela, Luxor, Even, Aura, Spin, Link+, Planet, Flat, Alambra, Abacus living, Self, Cover, Zenit, Dress bold, Abacus.

#### REGISTERED TRADEMARKS:

Rimadesio, Colorsystem, Litech, Siparium, Velaria, Abacus.



Follow us on Instagram, Facebook, LinkedIn,  
WeChat, Weibo, Little Red Book.

