

---

**DEAN**  
Oval Side Table

---

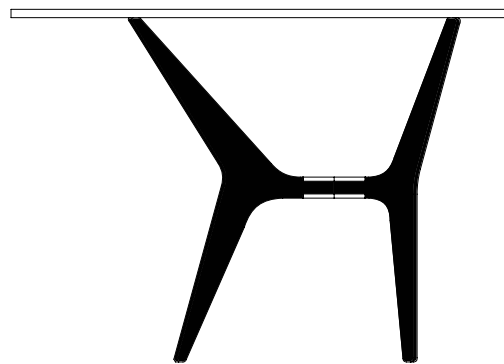

GABRIEL SCOTT  
EST 2012



# DEAN

## Oval Side Table

1/3

Inspired by silhouettes of mid-century modern design, DEAN tables feature clear or smoked glass tops which showcase the sculptural quality of the contrasted hardware below.

Light and elegant in appearance, the stylish x-base is available in black steel with brass hardware, all brass, or all copper options.

All Gabriel Scott pieces are handmade in Canada.



GABRIEL SCOTT

EST. 2012



DEAN  
Oval Side Table

2/3



GABRIEL SCOTT

EST. 2012



# DEAN

## Oval Side Table

3/3

### Spec sheet

Product name: Dean Oval Side Table

Standard Leadtime: 8 - 10 weeks

Dimensions: 20" x 30" x 21.5" H  
Tempered glass top: 1/2"

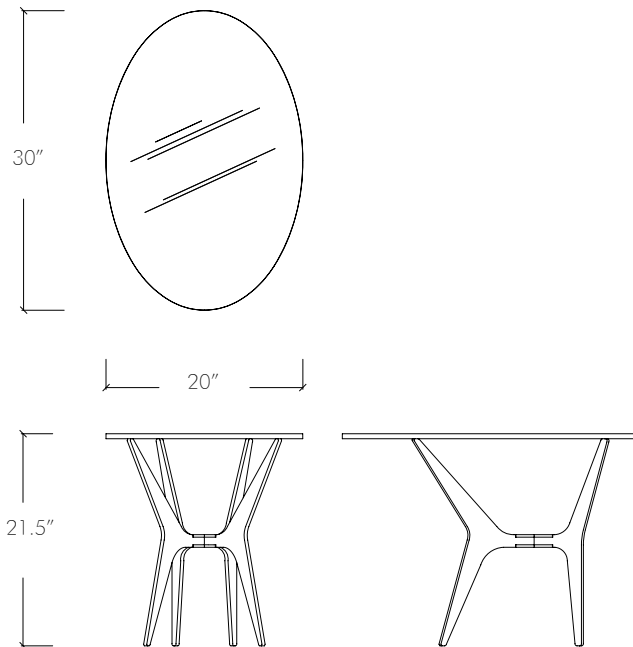

### Standard Finishes

Standard Base Finish Options:

**Blackened Steel Base / Satin Brass Hardware**  
**Satin Brass Base / Satin Brass Hardware**  
**Satin Copper base w/ Satin Copper Hardware**  
Custom-finishes may be available upon request

Glass Options:

**Clear**  
**Smoked**  
**Bronzed**



Clear Glass

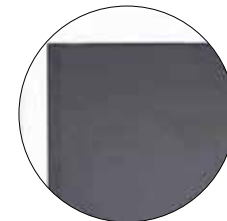

Smoked Glass

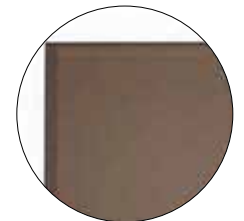

Bronzed Glass

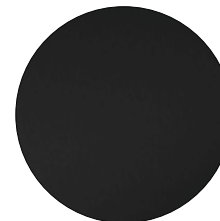

Blackened Steel

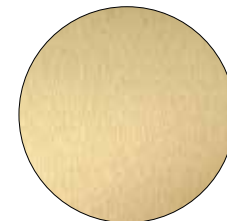

Satin Brass

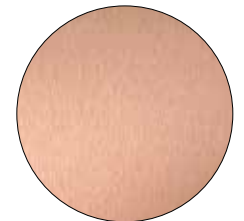

Satin Copper

GABRIEL SCOTT

EST. 2012

