



Struttura: in legno multistrato di vari spessori. Preparazione della struttura sedile, braccioli e schienali in poliuretano espanso a quote differenziate ad alta densità. Braccioli e schienali rivestiti successivamente con trapuntino di fibra di poliestere termolegata traspirante accoppiata con tela di cotone bianca.

Tutti i materiali impiegati per realizzare il trapuntino sono anallergici e prodotti con materiali riciclati.

La confezione della fodera della struttura schienale/bracciolo e dei cuscini sedile e schienale è contraddistinta da un profilo e da morbide impunture d'ispirazione couture che conferiscono un'immediata sensazione di comfort grazie alla leggera curva dello schienale e del bracciolo. Per aumentare la sofficietà, la fodera dello schienale/bracciolo prevede una trapuntatura che accoppia la fibra termolegata di forte spessore con la tela di cotone bianca, alla fodera.

Cuscineria: imbottitura cuscini sedile e schienale in piuma d'oca canalizzata ad alto spessore, per conferire grande sofficietà ed aumentare il comfort, sottoposta a regolare trattamento di bonifica igienico-sanitaria come stabilito dal Regolamento CE 1069/2009 (certificata Assopiuma, Etichetta Oro). Successivamente rivestiti da fibra termolegata traspirante accoppiata con tela di cotone bianca anallergica. Cuscini sedile con inserto in poliuretano espanso a quote differenziate ad alta resilienza, rivestito nella parte superiore con materiale poliuretano termosensibile. Cuscini schienale con inserto centrale in poliuretano espanso a quote differenziate ad alta resilienza in materiale anch'esso termosensibile e sagomato per adattarsi perfettamente alla raffinata e funzionale conformazione dello schienale imbottito.

Sfoderabilità: struttura, cuscini sedile e schienale completamente sfoderabili in tutte le versioni (tessuto o pelle).

Basi: portanti in estruso di alluminio verniciato lucido anti-touch color Bronzo e scivolante protettivo in polietilene di colore bronzo.

Per permettere la sfoderabilità, gli elementi schienale/bracciolo sono facilmente sfilabili dalle loro sedi agendo sulle apposite manopole poste sotto la struttura portante.

Questa operazione, in casi necessari, può essere eseguita anche per agevolare il trasporto e la consegna.

Structure: in plywood of various thicknesses. The seat, armrest and backrest structures are coated in high-resilience variable-density polyurethane foam. Armrests and backrest are then encased in a breathable heat-bonded quilted fibre laminated to white cotton fabric. All of the materials employed in manufacturing the quilting are hypoallergenic and made with recycled materials. Tailoring of the backrest/armrest structure upholstery and of the seat and backrest cushions is distinguished by piping and couture-inspired soft top-stitching that convey an immediate sense of comfort, thanks to the slight curve of the backrest and armrest.

To increase fluffiness, the backrest and armrest upholstery has quilting that joins the thick heat-bonded fibre encased in white cotton fabric to the upholstery.

Cushions: seat and backrest cushions, padded in high-loft channelled goose down to lend greater softness and increase comfort, undergo routine sanitization as specified in EC Regulation No. 1069/2009 (Assopiuma certified, Gold Label). They are then encased in breathable heat-bonded fibre laminated to white hypoallergenic cotton fabric. Seat cushions with high resilience, variable-density polyurethane foam insert are covered in the upper part with temperature-sensitive polyurethane material. Backrest cushions with core insert in high-resilience, variable-density polyurethane foam in material that is also temperature-sensitive and contoured to adapt perfectly to the sophisticated, functional shape of the upholstered backrest.

Covers: upholstery for the structure, seat and backrest cushions is completely removable in all versions (fabric and leather).

Bases: weight-bearing, in extruded aluminium varnished polished anti-fingerprint Bronze colour finish and bronze colour protective polyethylene glides.

For removal of upholstery, the backrest/armrest elements can easily be lifted out by releasing the levers located underneath the support structure. If needed, this operation can also be used to facilitate shipping and delivery.

Struktur: aus Sperrholz in verschiedenen Stärken. Polsterung der Sitzflächenstruktur, der Arm- und der Rückenlehnen aus PU-Schaum mit differenzierter, hoher Dichte. Arm- und Rückenlehnen mit zusätzlicher gesteppter Polsterung aus atmungsaktiver, thermofixierter Faser mit Bezug aus weißer, antiallergischer Baumwolle. Alle, für die gesteppte Polsterung verwendeten Materialien sind antiallergisch und bestehen aus recycelten Materialien.

Die Konfektionierung des Bezugs der Struktur von Rücken- und Armlehne und der Sitz- und Rückenlehnen zeichnet sich durch ein Profil und weiche Steppnähte aus, die sich an der Haute Couture inspirieren und mit der leicht geschwungenen Rückenlehne und Armlehne ein unmittelbares Gefühl von Komfort vermitteln.

Um den Sitzkomfort zu erhöhen, ist der Polsterung der Rückenlehne und der Armlehne mit einer Steppung ausgeführt, die die thermofixierte, sehr dicke Faser mit Bezug aus weißer Baumwolle mit der Polsterung verbindet.

Kissen: Rücken- und Sitzkissen mit gesteppter Daunenfüllung mit Kammern und Innenstegen mit hoher Stärke für weiche Kissen und mehr Sitzkomfort, die nach Vorgabe der Verordnung (EU) 1069/2009 (zertifiziert Assopiuma, "Goldenes Etikett") ordnungsgemäß sterilisiert worden ist. Zusätzliche Polsterung aus atmungsaktiver, thermofixierter Faser mit Bezug aus weißer, antiallergischer Baumwolle.

Sitzkissen mit zentralem Einsatz aus hochwiderstandsfähigem PU-Schaum mit differenzierter Dichte mit Polsterung auf der Oberseite mit thermosensitivem Memory-Schaum. Rückenkissen mit zentralem Einsatz aus hochwiderstandsfähigem PU-Schaum mit differenzierter Dichte, der ebenfalls thermosensitiv und geformt ist, um sich perfekt an die elegante und funktionelle Form der gepolsterten Rückenlehne anzupassen.

Abziehbarkeit: Struktur, Sitz- und Rückenlehnen sind in allen Versionen (Stoff oder Leder) komplett abziehbar.

Basis: Tragende Kufen aus extrudiertem Aluminium mit glänzender Anti-Touch-Lackierung und Schutzgleiter aus Polyethylen in der Farbe Bronze.

Für das Abziehen der Bezüge können die Rückenlehnen und Armlehnen mit Hilfe der speziellen Drehknöpfe unter der tragenden Basis leicht aus ihren Sitzen gezogen werden. Bei Bedarf kann diese Möglichkeit auch genutzt werden, um den Transport und die Lieferung des Sofas zu erleichtern.

Structure: en multipli de différentes épaisseurs. Préparation de la structure de l'assise, des accoudoirs et des dossiers en mousse polyuréthane à densité différenciée haute densité. Accoudoirs et dossiers recouverts ensuite d'un tissu multicouche matelassé en fibre de polyester thermoliée respirante et toile de coton blanche.

Tous les matériaux utilisés pour la réalisation du tissu multicouche matelassé sont hypoallergéniques et fabriqués à partir de matériaux recyclés.

La confection du revêtement de la structure dossier/accoudoir et des coussins de l'assise et du dossier est caractérisée par un cordon et par des surpiques souples d'inspiration couture qui procurent une sensation immédiate de confort due également à la légère courbure du dossier et de l'accoudoir.

Pour augmenter le moelleux, le revêtement du dossier/accoudoir est doublé d'un tissu multicouche matelassé en fibre thermoliée de forte épaisseur et toile de coton blanche.

Coussins: rembourrage des coussins d'assise et de dossier en plume d'oie cloisonnée de forte épaisseur pour apporter beaucoup de moelleux et augmenter le confort, soumise à un traitement d'assainissement conformément au règlement CE 1069/2009 (Certifiée Assopiuma, Label Or). Par la suite, ils sont recouverts d'un tissu multicouche en fibre thermoliée respirante et toile de coton blanche hypoallergénique. Coussins d'assise avec insert en mousse polyuréthane à densité différenciée haute résilience, recouvert sur le dessus de matériau polyuréthane termosensibile. Coussins de dossier avec insert central en mousse polyuréthane à densité différenciée haute résilience, également termosensibile et façonné pour épouser parfaitement les formes raffinées et fonctionnelles du dossier rembourré.

Déhoussage: structure, coussins d'assise et de dossier entièrement déhoussables dans toutes les versions (tissu ou cuir).

Piètements: portants, en aluminium extrudé peint couleur Bronze brillant anti-traces de doigt et patins glisseurs en polyéthylène de couleur bronze.

Pour permettre le déhoussage, les éléments dossier/accoudoir sont faciles à retirer de leur logement en tournant les poignées prévues à cet effet et situées sous la structure portante. Si nécessaire, cette opération peut également être effectuée pour faciliter le transport et la livraison.

Minotti

Tavolini: piano d'appoggio in stratificato di MDF e alluminio, spessore mm 18, impiallacciato in frassino laccato a poro aperto color Moka o tinto a poro aperto color Tabacco. Completamente sfoderabili in tutte le versioni (tessuto o pelle).

OPZIONE ALTEZZA BASI

A richiesta sono disponibili, senza sovrapprezzo, basi H 10,5 cm ovvero più alte di 3 cm rispetto alle basi di serie. Questa opzione deve essere specificata all'atto dell'ordine. Qualora non venisse indicato, verranno montate le basi con altezza STANDARD (7,5 cm).

Non è possibile realizzare la base di questo prodotto nei tessuti: Velvet, Gary, Hunt, Kabuki, Kerlin, Leopold, Tibet Square, Timothy.

POGGIATESTA

Realizzato in multistrato rivestito in poliuretano espanso ad alta densità, successivamente rivestito con fibra termolegata traspirante accoppiata con tela di cotone bianca. Per migliorare l'aderenza dell'elemento alla seduta, all'interno della fascia, in corrispondenza del cuscino sedile, è stato inserito un contrappeso. La fodera può essere realizzata a scelta nei tessuti o pelli a campionario, qualora non venisse specificata all'atto dell'ordine verrà coordinata al rivestimento del divano. Tessuto antiscivolo sul fondo. Completamente sfoderabile.

Coffee tables: table-top surface in laminated MDF and aluminium, 18 mm thick, in ash veneer with open pore Moka colour lacquer finish or open-pore Tobacco colour stain. Upholstery is completely removable in all versions (fabric and leather).

BASE HEIGHT OPTIONS

Available upon request, 10.5 cm high base, no surcharge; 3 cm higher than the standard base. This option must be specified at the time the order is placed. Failure to indicate the option will result in mounting of STANDARD height base (7.5 cm).

It is not possible to make the base of this product using the following fabrics: Velvet, Gary, Hunt, Kabuki, Kerlin, Leopold, Tibet Square, Timothy.

HEADREST

Made of plywood coated in high-resilience polyurethane foam, then sheathed in breathable, heat-bonded fiber laminated to white cotton canvas. To improve adherence of the element to the seat, a counterweight is inserted inside the fabric strip where it meets the seat cushion. Headrest upholstery can be chosen from among the fabric or leather in the sample books; if not specified at the time the order is placed, it will be matched to the sofa upholstery. Non-slip fabric on the bottom. Cover completely removable.

Beistelltische: ablagefläche aus MDF-Schichtholz und Aluminium, Stärke 18 mm vor, in der Ausführung Eschenholzfurnier offenporig lackiert in der Farbe Mokka oder gebeizt in der Farbe Tabak. In allen Versionen (Stoff oder Leder) komplett abziehbar.

OPTION HÖHE DER BASIS

Auf Anfrage hin ist, ohne Aufpreis, die 10,5 cm hohe Basis erhältlich, also 3 cm höher als die serienmäßige Ausführung. Diese Option muss bei der Bestellung angegeben werden. Ohne spezifische Angabe wird die STANDARD-Basis (7,5 cm hoch) montiert.

Die Basis dieses Produkts kann nicht mit folgenden Stoffen hergestellt werden: Velvet, Gary, Hunt, Kabuki, Kerlin, Leopold, Tibet Square, Timothy.

KOPFSTÜTZE

Aus Sperrholz mit Beschichtung aus PU-Schaum mit hoher Dichte, Polsterung mit atmungsaktiver temperaturregulierter Faser und Bezug aus weißer Baumwolle. Damit die Kopfstütze perfekt an der Sitzfläche anliegt, befindet sich im Band auf Höhe des Sitzkissens ein Gegengewicht. Der Bezug kann auf Wunsch mit Stoff oder Leder aus der Musterkollektion ausgeführt werden. Wenn bei der Bestellung keine Angaben gemacht werden, wird der gleiche Bezug wie für das Sofa verwendet. Rutschfestes Gewebe am Boden des Elements. Komplett abziehbar.

Petites tables : tablettes en MDF stratifié et aluminium, de 18 mm d'épaisseur, plaquée frêne laqué à pores ouverts couleur Moka ou teinté à pores ouverts couleur Tabac. Entièrement déhoussables dans toutes les versions (tissu ou cuir).

OPTION HAUTEUR DES BASES

Des piètements H 10,5 cm, à savoir 3 cm plus hauts que les piètements de série, sont disponibles sur demande, sans surcout. Cette option doit être spécifiée lors de la commande. En cas de non-indication, les piètements de la hauteur STANDARD (7,5 cm) seront montés.

Il n'est pas possible de réaliser le piètement de ce produit dans les tissus suivants : Velvet, Gary, Hunt, Kabuki, Kerlin, Leopold, Tibet Square, Timothy.

APPUI-TÊTE

Fabriqué en multiplis recouvert de polyuréthane expansé haute densité, puis de fibre thermocollée respirante doublée de toile de coton blanche. Pour améliorer l'adhérence de l'élément à l'assise, un contrepoids a été inséré à l'intérieur de la bande, au niveau du coussin d'assise. La housse peut être confectionnée au choix dans les tissus ou les cuirs de la collection, elle sera assortie au revêtement du canapé si le choix n'est pas spécifié lors de la commande. Tissu antidérapant sur le bas. Entièrement déhoussable.

OPZIONI ALTEZZA BASI | BASES HEIGHT OPTIONS

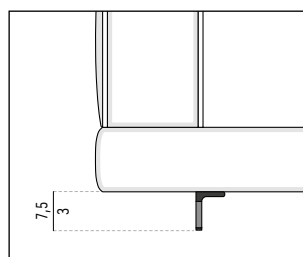

VERSIONE STANDARD
STANDARD VERSION

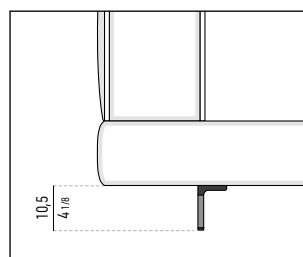

VERSIONE HIGH
HIGH VERSION

BASI BASES

ALLUMINIO LUCIDO POLISHED ALUMINIUM

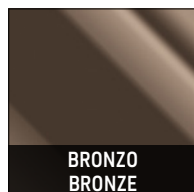

BRONZO
BRONZE

PIANI D'APPOGGIO - TAVOLINI TABLE-TOP SURFACES - COFFEE TABLES

FRASSINO ASH

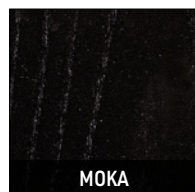

MOKA

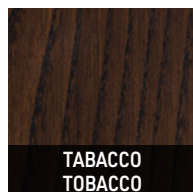

TABACCO
TOBACCO

Minotti

MODULO DI SEDUTA **CM 77**
SEAT CUSHION **CM 77**

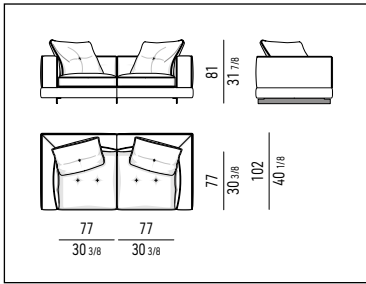

MODULO DI SEDUTA **CM 68**
SEAT CUSHION **CM 68**

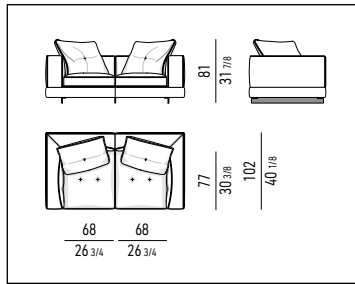

MODULO DI SEDUTA **ELEMENTI ANGOLARI CM 68/77**
CORNER ELEMENTS SEAT CUSHION CM 68/77

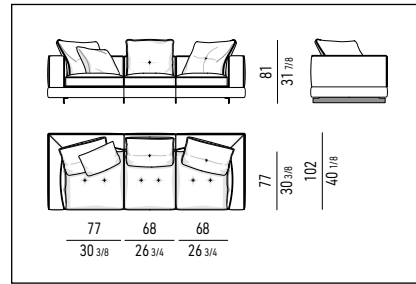

MODULO DI SEDUTA **ELEMENTI LOUNGE THEATRE CM 57**
LOUNGE THEATRE ELEMENTS SEAT CUSHION CM 57

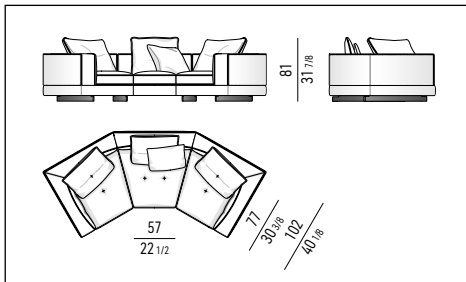

ANGOLO ELEMENTI INCLINATI / LOUNGE THEATRE
ANGLE INCLINED ELEMENTS / LOUNGE THEATRE

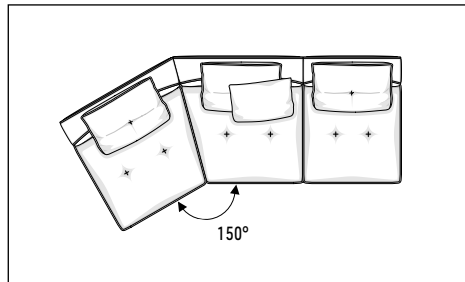

MODULO DI SEDUTA 77 CM | SEAT CUSHION 77 CM

DIVANI | SOFAS

LOW DIVANO CM 204
LOW SOFA CM 204

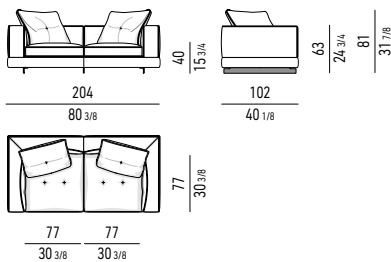

LOW DIVANO CM 283
LOW SOFA CM 283

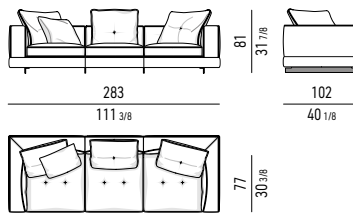

LOW DIVANO OPEN CM 283
LOW OPEN SOFA CM 283

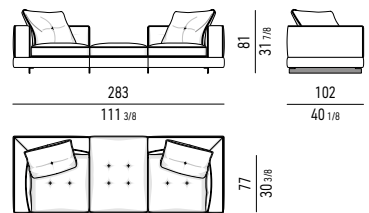

DIVANI DAYBED | DAYBED SOFAS

LOW DIVANO DAYBED CM 204
LOW DAYBED SOFA CM 204

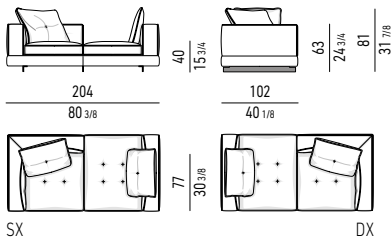

LOW DIVANO DAYBED CM 283
LOW DAYBED SOFA CM 283

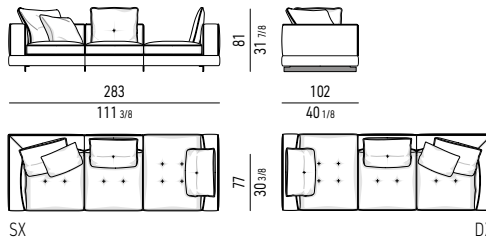

ELEMENTI DAYBED | DAYBED ELEMENTS

LOW ELEMENTO DAYBED CM 181
LOW DAYBED ELEMENT CM 181

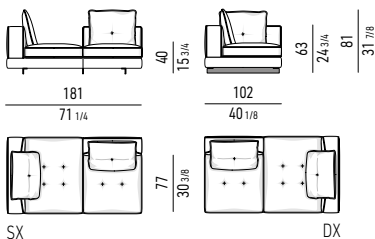

LOW ELEMENTO DAYBED CM 260
LOW DAYBED ELEMENT CM 260

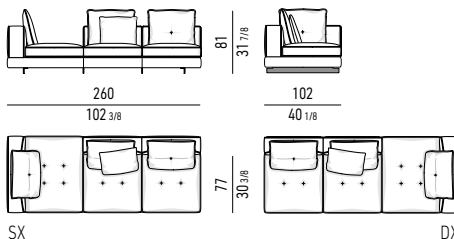

ELEMENTI TERMINALI | ELEMENTS WITH 1 ARMREST

LOW ELEMENTO ANGOLARE TERMINALE CM 102
LOW CORNER ELEMENT WITH 1 ARMREST CM 102

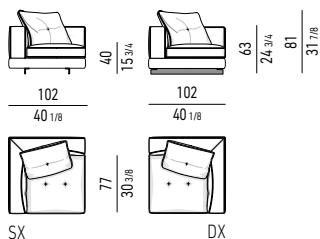

LOW ELEMENTO TERMINALE CM 181
LOW ELEMENT WITH 1 ARMREST CM 181

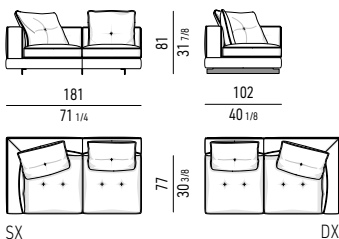

LOW ELEMENTO TERMINALE CM 260
LOW ELEMENT WITH 1 ARMREST CM 260

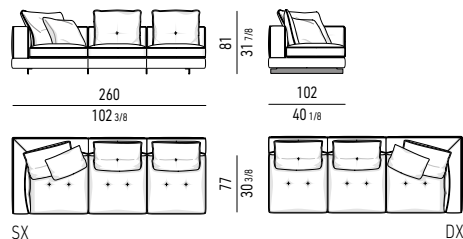

LOW ELEMENTO TERMINALE OPEN CM 260
LOW OPEN ELEMENT WITH 1 ARMREST CM 260

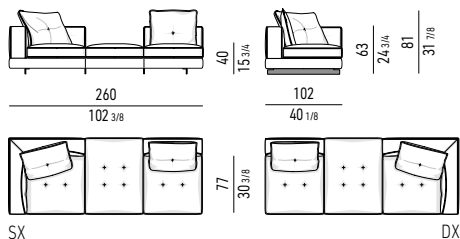

ELEMENTI TERMINALI PENISOLA | OPEN-END ELEMENTS WITH ARMREST

LOW ELEMENTO TERMINALE PENISOLA CM 181
LOW OPEN-END ELEMENT WITH ARMREST CM 181

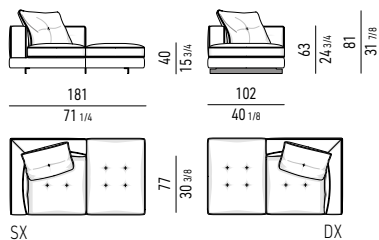

LOW ELEMENTO TERMINALE PENISOLA CM 260
LOW OPEN-END ELEMENT WITH ARMREST CM 260

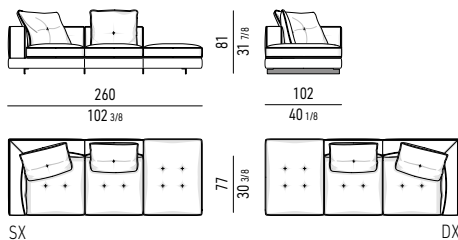

LOW ELEMENTO TERMINALE PENISOLA CM 204
LOW OPEN-END ELEMENT WITH ARMREST CM 204

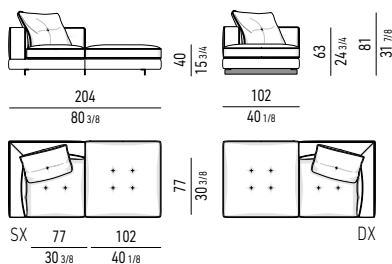

LOW ELEMENTO TERMINALE PENISOLA CM 283
LOW OPEN-END ELEMENT WITH ARMREST CM 283

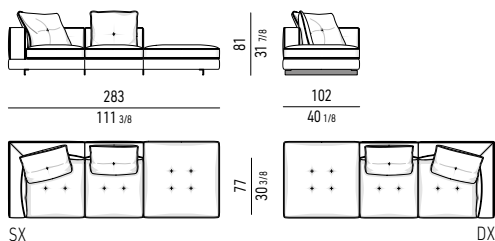

ELEMENTI CENTRALI | CENTRAL ELEMENTS

LOW ELEMENTO CENTRALE CM 79
LOW CENTRAL ELEMENT CM 79

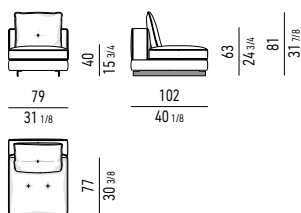

LOW ELEMENTO CENTRALE CM 158
LOW CENTRAL ELEMENT CM 158

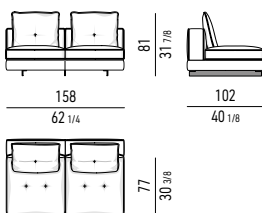

LOW ELEMENTO CENTRALE CM 237
LOW CENTRAL ELEMENT CM 237

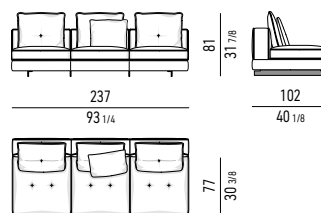

Minotti

LOW ELEMENTO CENTRALE OPEN CM 237 LOW OPEN CENTRAL ELEMENT CM 237

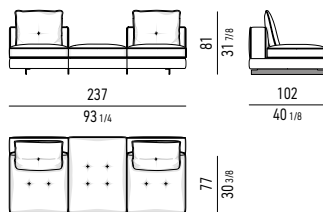

ELEMENTI PENISOLA | OPEN-END ELEMENTS

LOW ELEMENTO PENISOLA CM 158 LOW OPEN-END ELEMENT CM 158

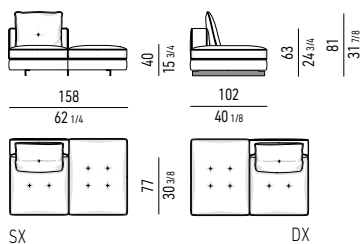

LOW ELEMENTO PENISOLA CM 237 LOW OPEN-END ELEMENT CM 237

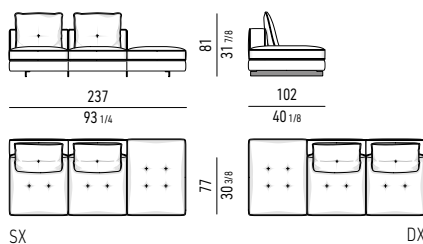

LOW ELEMENTO PENISOLA CM 181 LOW OPEN-END ELEMENT CM 181

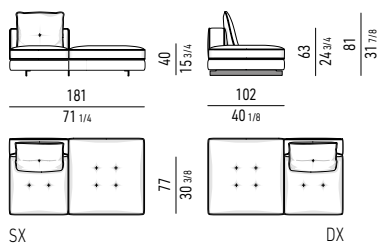

LOW ELEMENTO PENISOLA CM 260 LOW OPEN-END ELEMENT CM 260

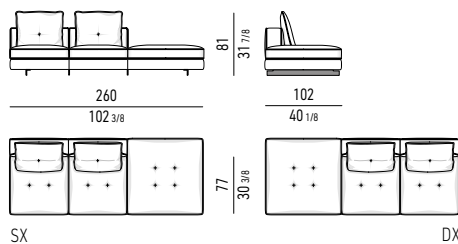

COUCHES

LOW COUCH CM 79X158 LOW COUCH CM 79X158

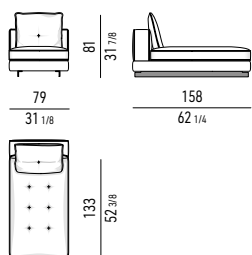

LOW COUCH CM 117X140 - SCHIENALE UNICO LOW COUCH CM 117X140 - SINGLE BACKREST

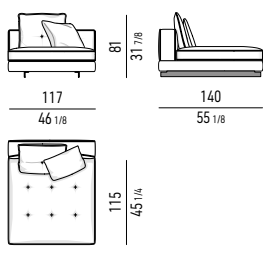

LOW DOPPIO COUCH CM 158X158 LOW DOUBLE COUCH CM 158X158

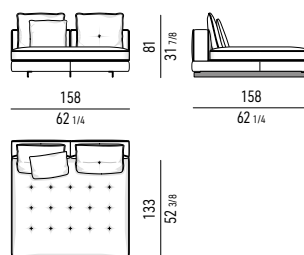

LOW DOPPIO COUCH CM 158X181 LOW DOUBLE COUCH CM 158X181

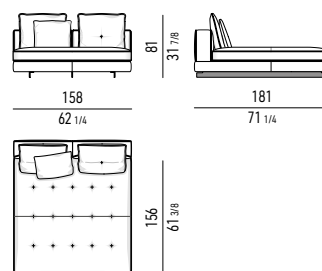

CHAISE-LONGUES

LOW CHAISE-LONGUE CM 140X140 - SCHIENALE UNICO LOW CHAISE-LONGUE CM 140X140 - SINGLE BACKREST

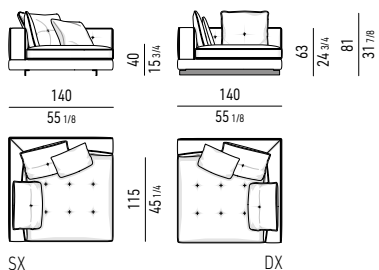

LOW CHAISE-LONGUE CM 181X181 LOW CHAISE-LONGUE CM 181X181

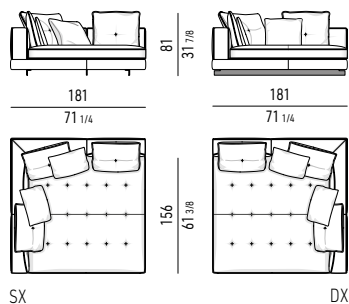

Minotti

DIVANI INCLINATI | INCLINED SOFAS

LOW DIVANO INCLINATO CM 238X152
LOW INCLINED SOFA CM 238X152

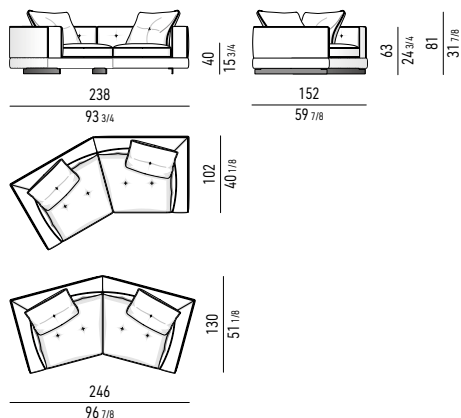

LOW DIVANO INCLINATO CM 317X152
LOW INCLINED SOFA CM 317X152

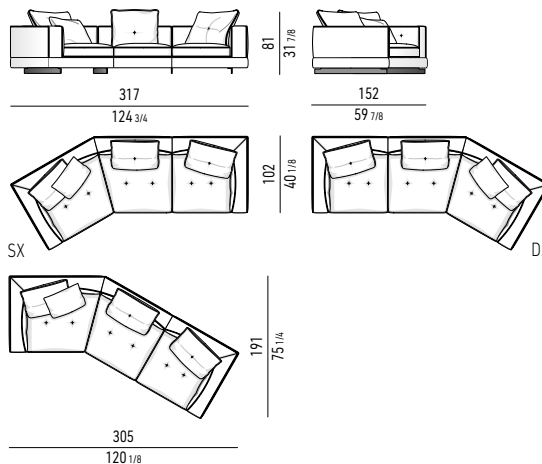

ELEMENTI TERMINALI INCLINATI | INCLINED ELEMENTS WITH ARMREST

LOW ELEMENTO TERMINALE INCLINATO CM 215X152
LOW INCLINED ELEMENT WITH ARMREST CM 215X152

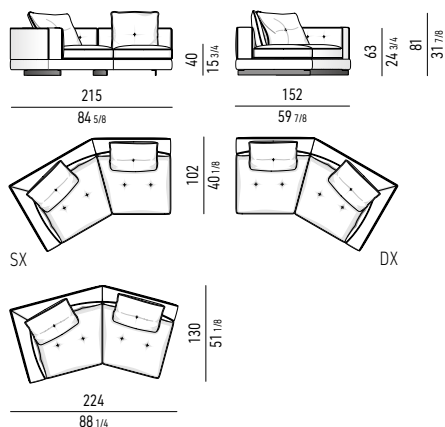

LOW ELEMENTO TERMINALE INCLINATO CM 294X152
LOW INCLINED ELEMENT WITH ARMREST CM 294X152

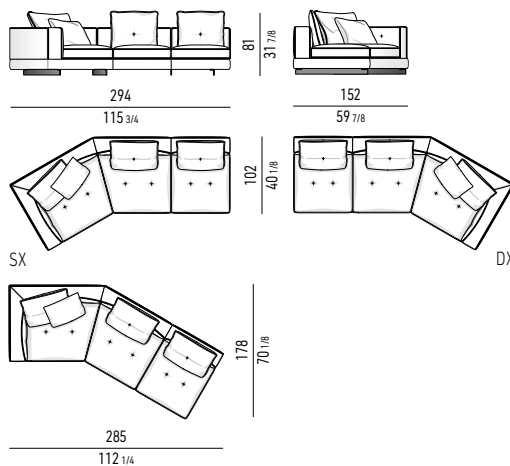

LOW ELEMENTO TERMINALE INCLINATO CM 296X140
LOW INCLINED ELEMENT WITH ARMREST CM 296X140

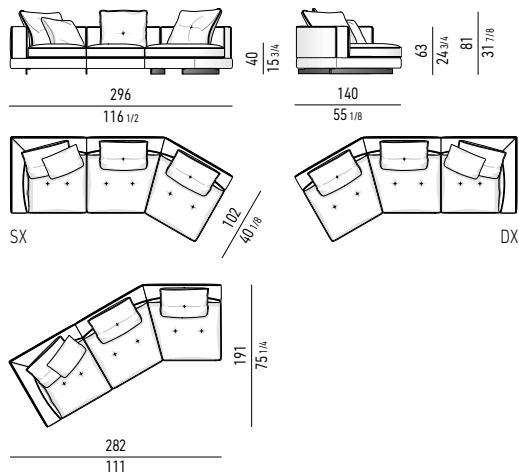

ELEMENTI CENTRALI INCLINATI | INCLINED CENTRAL ELEMENTS

LOW ELEMENTO CENTRALE INCLINATO CM 194X140
LOW INCLINED CENTRAL ELEMENT CM 194X140

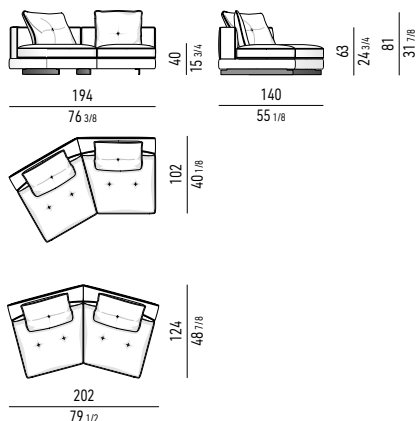

LOW ELEMENTO CENTRALE INCLINATO CM 273X140
LOW INCLINED CENTRAL ELEMENT CM 273X140

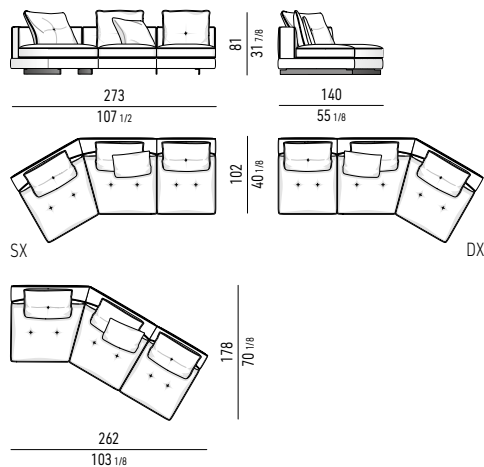

ELEMENTI "THEATRE" | "THEATRE" ELEMENTS *

* N.B.: IL LATO CON MISURA INDICATA 106 CM PUÒ ESSERE UTILIZZATO SOLO IN COMPOSIZIONE CON ALTRI ELEMENTI THEATRE.
 N.B.: THE 106 CM SIDE CAN BE USED TO JOIN ONLY OTHER THEATRE ELEMENTS.

LOW ELEMENTO TERMINALE THEATRE CM 127
LOW THEATRE ELEMENT WITH 1 ARMREST CM 127

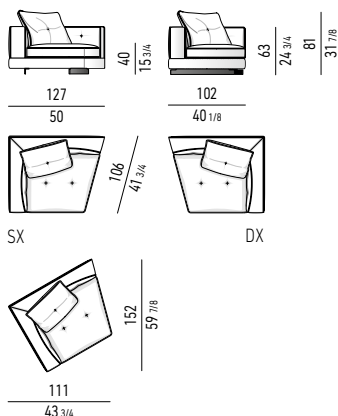

LOW ELEMENTO TERMINALE THEATRE CM 206
LOW THEATRE ELEMENT WITH 1 ARMREST CM 206

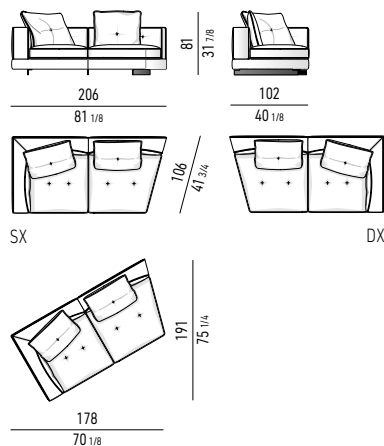

LOW ELEMENTO TERMINALE THEATRE CM 285
LOW THEATRE ELEMENT WITH 1 ARMREST CM 285

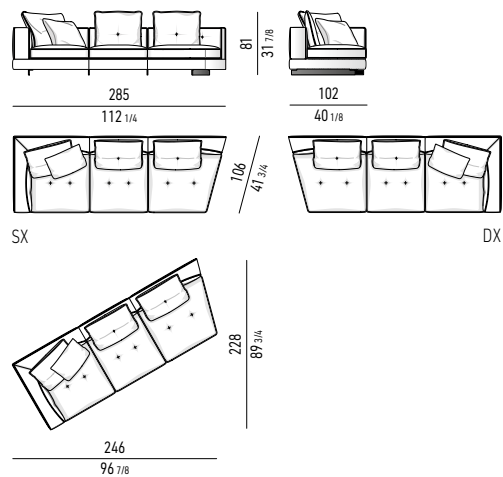

LOW ELEMENTO CENTRALE SIMMETRICO THEATRE CM 129
LOW THEATRE SYMMETRICAL CENTRAL ELEMENT CM 129

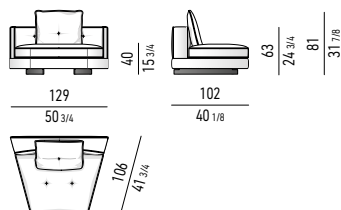

LOW ELEMENTO CENTRALE SIMMETRICO THEATRE CM 208
LOW THEATRE SYMMETRICAL CENTRAL ELEMENT CM 208

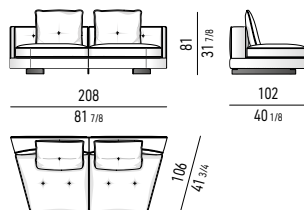

LOW ELEMENTO CENTRALE SIMMETRICO THEATRE CM 287
LOW THEATRE SYMMETRICAL CENTRAL ELEMENT CM 287

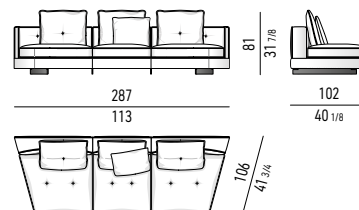

LOW ELEMENTO CENTRALE ASIMMETRICO THEATRE CM 104
LOW THEATRE ASYMMETRICAL CENTRAL ELEMENT CM 104

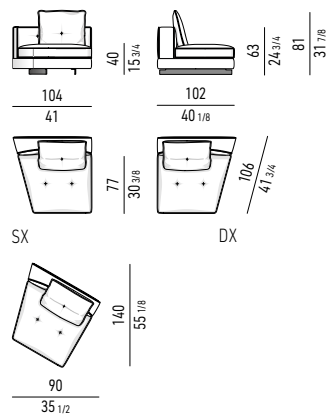

LOW ELEMENTO CENTRALE ASIMMETRICO THEATRE CM 183
LOW THEATRE ASYMMETRICAL CENTRAL ELEMENT CM 183

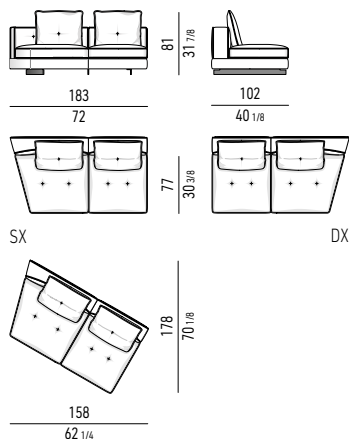

LOW ELEMENTO CENTRALE ASIMMETRICO THEATRE CM 262
LOW THEATRE ASYMMETRICAL CENTRAL ELEMENT CM 262

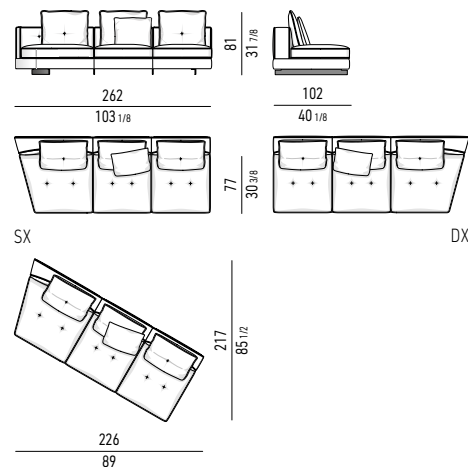

MODULO DI SEDUTA 68 CM | SEAT CUSHION 68 CM

DIVANI | SOFAS

LOW DIVANO CM 186
LOW SOFA CM 186

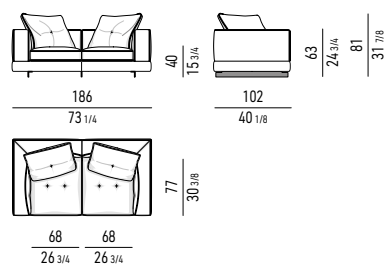

LOW DIVANO CM 256
LOW SOFA CM 256

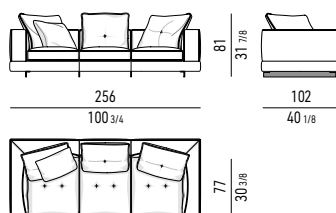

LOW DIVANO OPEN CM 256
LOW OPEN SOFA CM 256

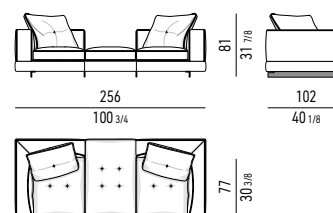

DIVANI DAYBED | DAYBED SOFAS

LOW DIVANO DAYBED CM 186
LOW DAYBED SOFA CM 186

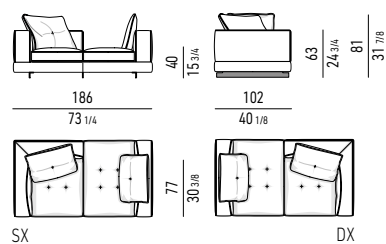

LOW DIVANO DAYBED CM 256
LOW DAYBED SOFA CM 256

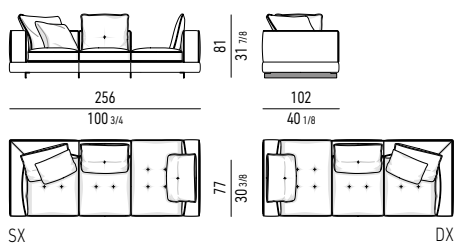

ELEMENTI DAYBED | DAYBED ELEMENTS

LOW ELEMENTO DAYBED CM 163
LOW DAYBED ELEMENT CM 163

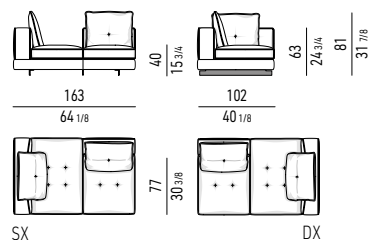

LOW ELEMENTO DAYBED CM 233
LOW DAYBED ELEMENT CM 233

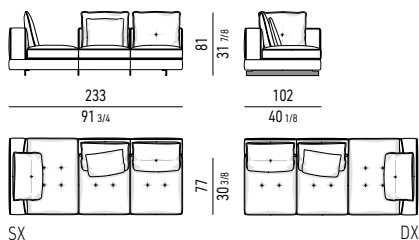

ELEMENTI TERMINALI | ELEMENTS WITH 1 ARMREST

LOW ELEMENTO TERMINALE CM 93
LOW ELEMENT WITH ARMREST CM 93

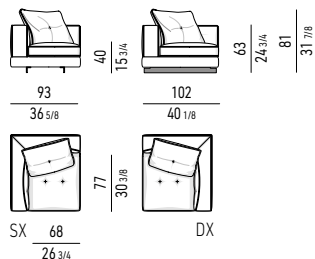

LOW ELEMENTO TERMINALE CM 163
LOW ELEMENT WITH ARMREST CM 163

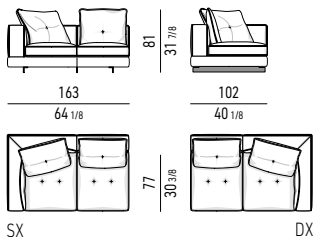

LOW ELEMENTO TERMINALE CM 233
LOW ELEMENT WITH ARMREST CM 233

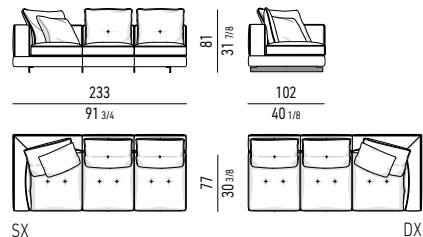

LOW ELEMENTO TERMINALE OPEN CM 233
LOW OPEN ELEMENT WITH ARMREST CM 233

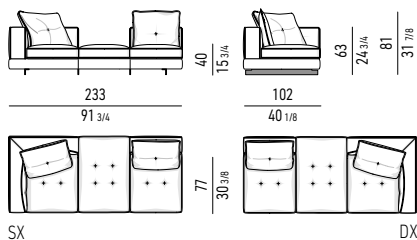

ELEMENTI TERMINALI PENISOLA | OPEN-END ELEMENTS WITH ARMREST

LOW ELEMENTO TERMINALE PENISOLA CM 163
LOW OPEN-END ELEMENT WITH ARMREST CM 163

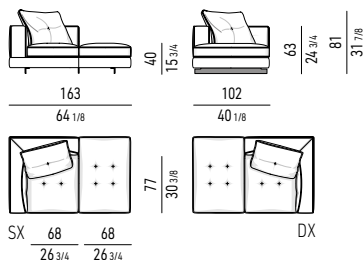

LOW ELEMENTO TERMINALE PENISOLA CM 233
LOW OPEN-END ELEMENT WITH ARMREST CM 233

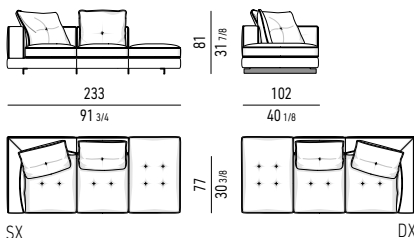

LOW ELEMENTO TERMINALE PENISOLA CM 186
LOW OPEN-END ELEMENT WITH ARMREST CM 186

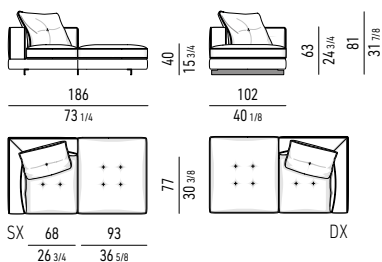

LOW ELEMENTO TERMINALE PENISOLA CM 256
LOW OPEN-END ELEMENT WITH ARMREST CM 256

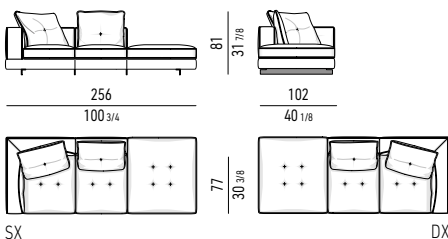

ELEMENTI CENTRALI | CENTRAL ELEMENTS

LOW ELEMENTO CENTRALE CM 70
LOW CENTRAL ELEMENT CM 70

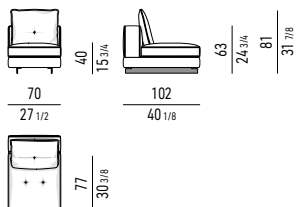

LOW ELEMENTO CENTRALE CM 140
LOW CENTRAL ELEMENT CM 140

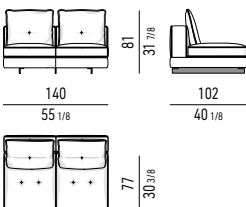

LOW ELEMENTO CENTRALE CM 210
LOW CENTRAL ELEMENT CM 210

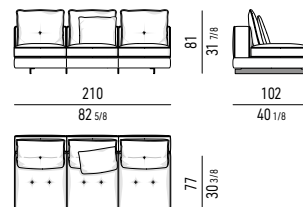

Minotti

LOW ELEMENTO CENTRALE OPEN CM 210 LOW OPEN CENTRAL ELEMENT CM 210

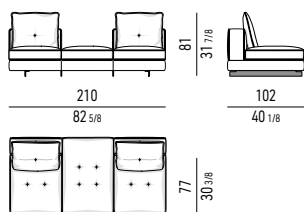

ELEMENTI PENISOLA | OPEN-END ELEMENTS

LOW ELEMENTO PENISOLA CM 140 LOW OPEN-END ELEMENT CM 140

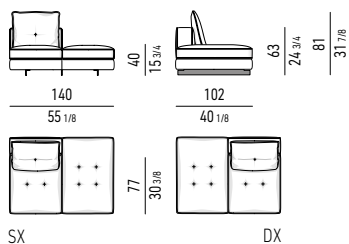

LOW ELEMENTO PENISOLA CM 210 LOW OPEN-END ELEMENT CM 210

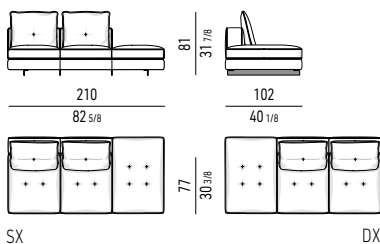

LOW ELEMENTO PENISOLA CM 163 LOW OPEN-END ELEMENT CM 163

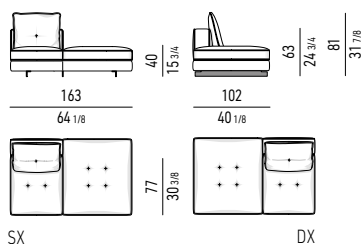

LOW ELEMENTO PENISOLA CM 233 LOW OPEN-END ELEMENT CM 233

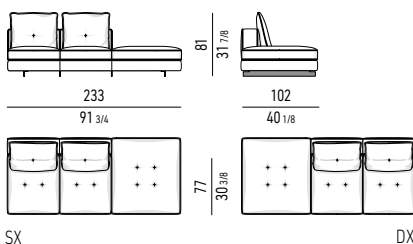

COUCHES

LOW COUCH CM 70X158 LOW COUCH CM 70X158

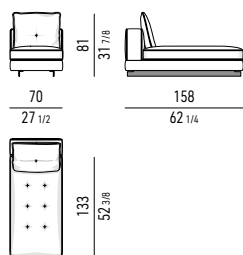

LOW COUCH CM 117X140 - SCHIENALE UNICO LOW COUCH CM 117X140 - SINGLE BACKREST

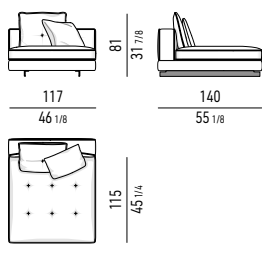

LOW DOPPIO COUCH CM 140X158 LOW DOUBLE COUCH CM 140X158

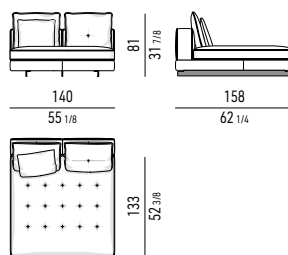

LOW DOPPIO COUCH CM 140X181 LOW DOUBLE COUCH CM 140X181

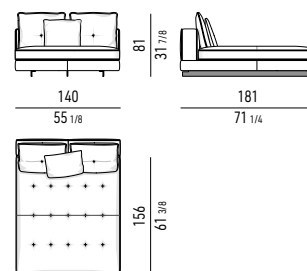

CHAISE-LONGUES

LOW CHAISE-LONGUE CM 140X140 - SCHIENALE UNICO LOW CHAISE-LONGUE CM 140X140 - SINGLE BACKREST

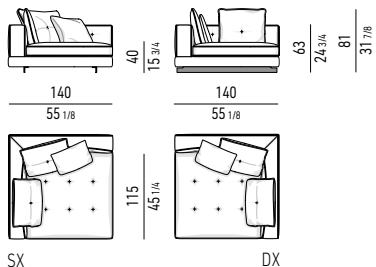

LOW CHAISE-LONGUE CM 163X181 LOW CHAISE-LONGUE CM 163X181

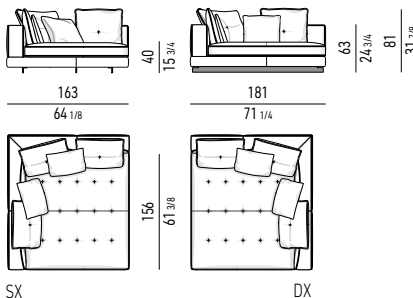

DIVANI INCLINATI | INCLINED SOFAS

LOW DIVANO INCLINATO CM 221X147 LOW INCLINED SOFA CM 221X147

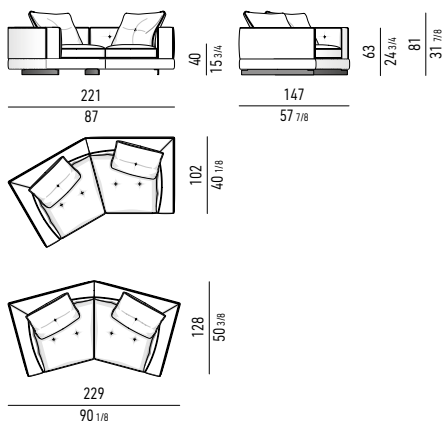

LOW DIVANO INCLINATO CM 291X147 LOW INCLINED SOFA CM 291X147

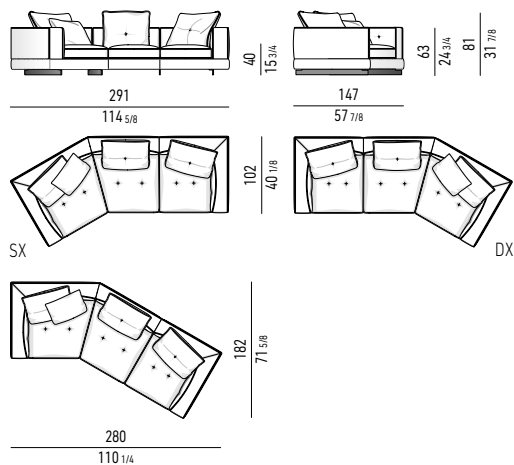

ELEMENTI TERMINALI INCLINATI | INCLINED ELEMENTS WITH ARMREST

LOW ELEMENTO TERMINALE INCLINATO CM 198X147 LOW INCLINED ELEMENT WITH ARMREST CM 198X147

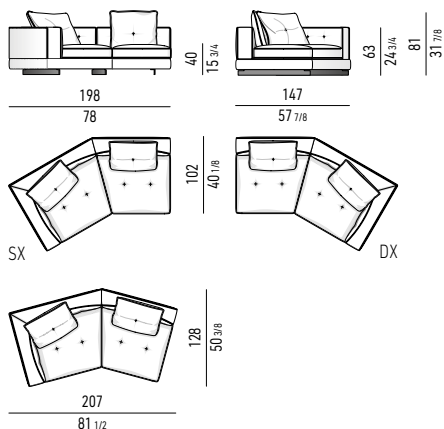

LOW ELEMENTO TERMINALE INCLINATO CM 268X147 LOW INCLINED ELEMENT WITH ARMREST CM 268X147

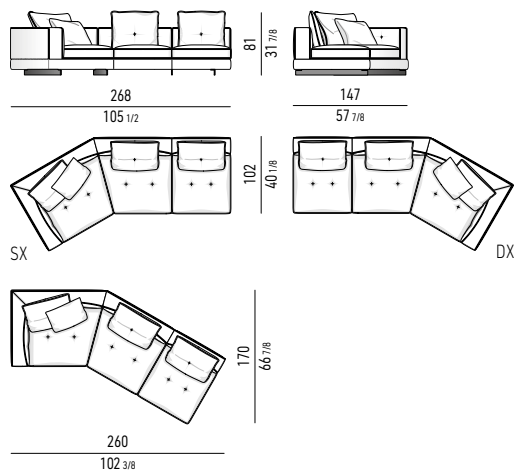

LOW ELEMENTO TERMINALE INCLINATO CM 270X135 LOW INCLINED ELEMENT WITH ARMREST CM 270X135

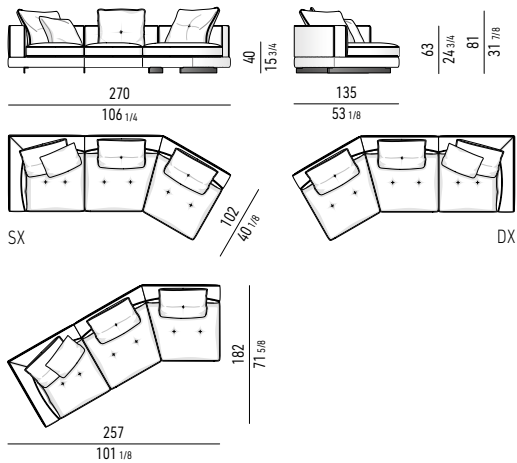

ELEMENTI CENTRALI INCLINATI | INCLINED CENTRAL ELEMENTS

LOW ELEMENTO CENTRALE INCLINATO CM 177X135
LOW INCLINED CENTRAL ELEMENT CM 177X135

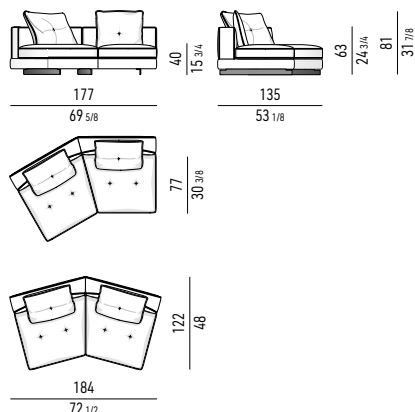

LOW ELEMENTO CENTRALE INCLINATO CM 247X135
LOW INCLINED CENTRAL ELEMENT CM 247X135

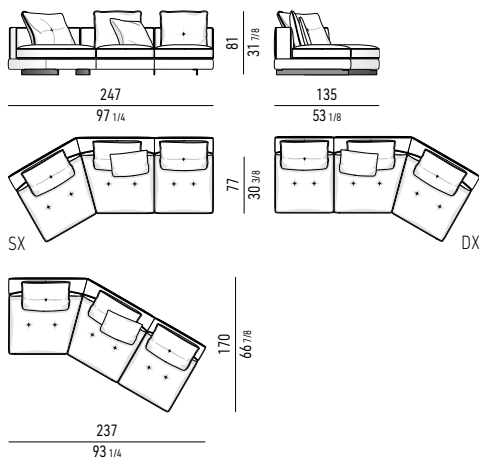

ELEMENTI "THEATRE" | "THEATRE" ELEMENTS *

* N.B.: IL LATO CON MISURA INDICATA 106 CM PUÒ ESSERE UTILIZZATO SOLO IN COMPOSIZIONE CON ALTRI ELEMENTI THEATRE.
 N.B.: THE 106 CM SIDE CAN BE USED TO JOIN ONLY OTHER THEATRE ELEMENTS.

LOW ELEMENTO TERMINALE THEATRE CM 118
LOW THEATRE ELEMENT WITH 1 ARMREST CM 118

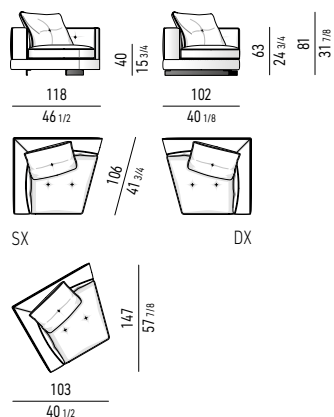

LOW ELEMENTO TERMINALE THEATRE CM 188
LOW THEATRE ELEMENT WITH 1 ARMREST CM 188

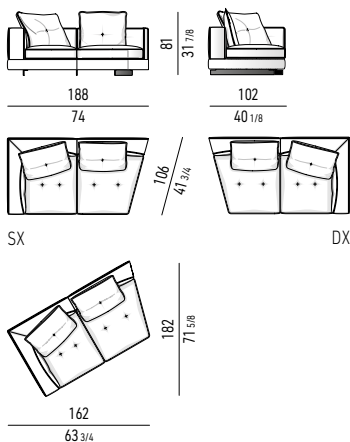

LOW ELEMENTO TERMINALE THEATRE CM 258
LOW THEATRE ELEMENT WITH 1 ARMREST CM 258

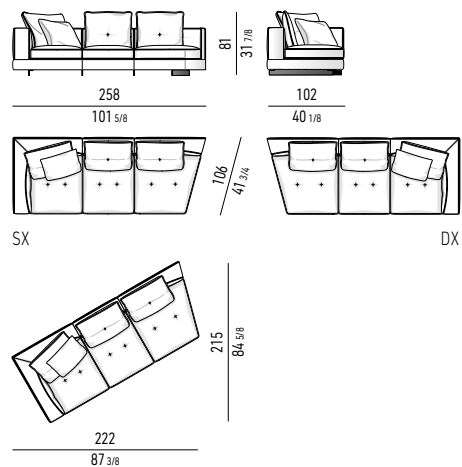

LOW ELEMENTO CENTRALE SIMMETRICO THEATRE CM 120
LOW THEATRE SYMMETRICAL CENTRAL ELEMENT CM 120

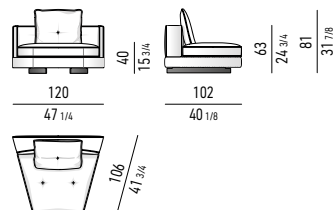

LOW ELEMENTO CENTRALE SIMMETRICO THEATRE CM 190
LOW THEATRE SYMMETRICAL CENTRAL ELEMENT CM 190

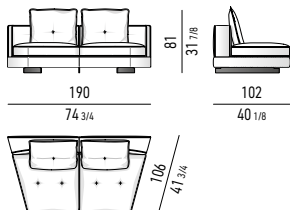

LOW ELEMENTO CENTRALE SIMMETRICO THEATRE CM 260
LOW THEATRE SYMMETRICAL CENTRAL ELEMENT CM 260

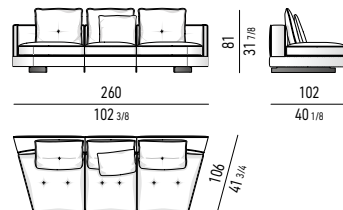

ELEMENTI "THEATRE" | "THEATRE" ELEMENTS

LOW ELEMENTO CENTRALE ASIMMETRICO THEATRE CM 95
LOW THEATRE ASYMMETRICAL CENTRAL ELEMENT CM 95

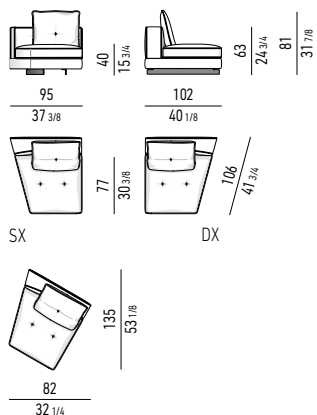

LOW ELEMENTO CENTRALE ASIMMETRICO THEATRE CM 165
LOW THEATRE ASYMMETRICAL CENTRAL ELEMENT CM 165

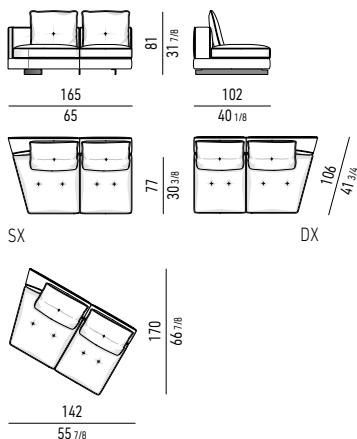

LOW ELEMENTO CENTRALE ASIMMETRICO THEATRE CM 235
LOW THEATRE ASYMMETRICAL CENTRAL ELEMENT CM 235

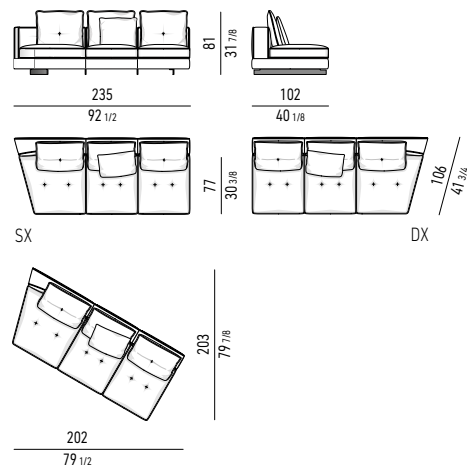

ELEMENTI ANGOLARI | CORNER ELEMENTS

DIVANI ANGOLARI | CORNER SOFAS

LOW DIVANO ANGOLARE CM 265
LOW CORNER SOFA CM 265

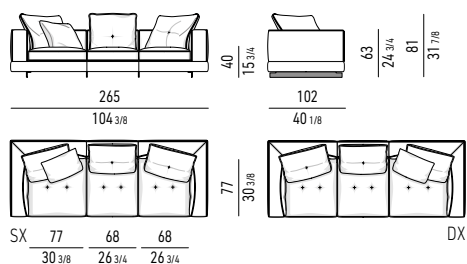

LOW DIVANO ANGOLARE OPEN CM 265
LOW CORNER OPEN SOFA CM 265

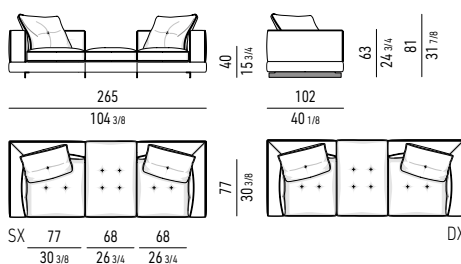

LOW DIVANO ANGOLARE DAYBED CM 265
LOW CORNER DAYBED SOFA CM 265

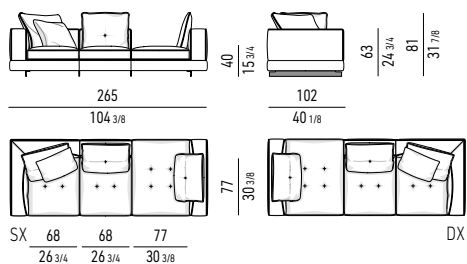

LOW ELEMENTO ANGOLARE DAYBED CM 242
LOW CORNER DAYBED ELEMENT CM 242

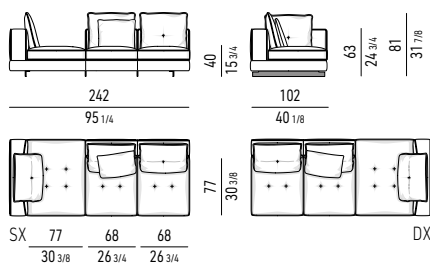

ELEMENTI ANGOLARI TERMINALI | CORNER ELEMENTS WITH ARMREST

LOW ELEMENTO ANGOLARE TERMINALE CM 102
LOW CORNER ELEMENT WITH 1 ARMREST CM 102

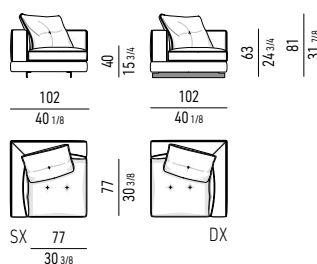

LOW ELEMENTO ANGOLARE TERMINALE CM 242
LOW CORNER ELEMENT WITH ARMREST CM 242

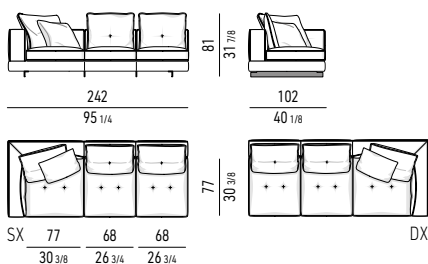

LOW ELEMENTO ANGOLARE TERMINALE OPEN CM 242
LOW CORNER OPEN ELEMENT WITH ARMREST CM 242

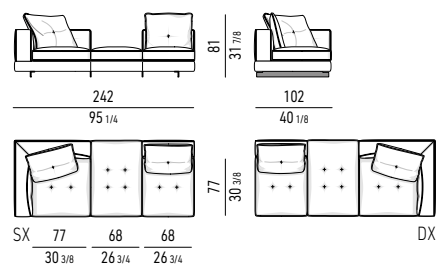

Minotti

ELEMENTI ANGOLARI PENISOLA | CORNER OPEN-END ELEMENTS

LOW ELEMENTO ANGOLARE TERMINALE PENISOLA CM 242
LOW CORNER OPEN-END ELEMENT WITH ARMREST CM 242

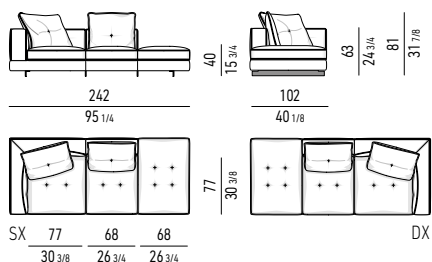

LOW ELEMENTO ANGOLARE TERMINALE PENISOLA CM 265
LOW CORNER OPEN-END ELEMENT WITH ARMREST CM 265

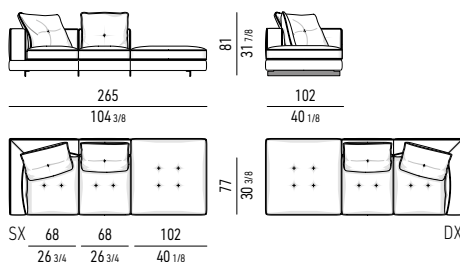

LOW ELEMENTO ANGOLARE PENISOLA CM 242
LOW CORNER OPEN-END ELEMENT CM 242

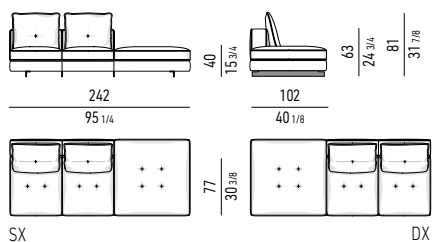

ELEMENTI "LOUNGE THEATRE" | "LOUNGE THEATRE" ELEMENTS

LOW DIVANO INCLINATO LOUNGE THEATRE CM 295X142
LOW LOUNGE THEATRE INCLINED SOFA CM 295X142

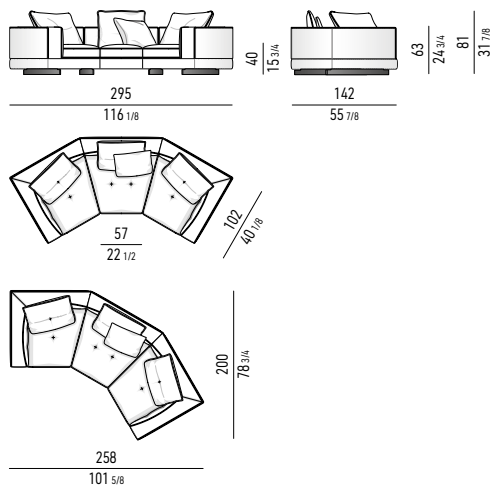

LOW DIVANO INCLINATO LOUNGE THEATRE CON 1 BRACCIOLO CM 275X142
LOW LOUNGE THEATRE INCLINED SOFA WITH 1 ARMREST CM 275X142

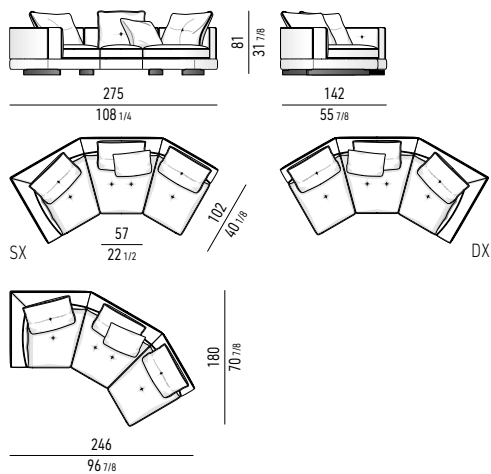

LOW DIVANO INCLINATO LOUNGE THEATRE SENZA BRACCIOLI CM 255X130
LOW LOUNGE THEATRE INCLINED SOFA WITHOUT ARMRESTS CM 255X130

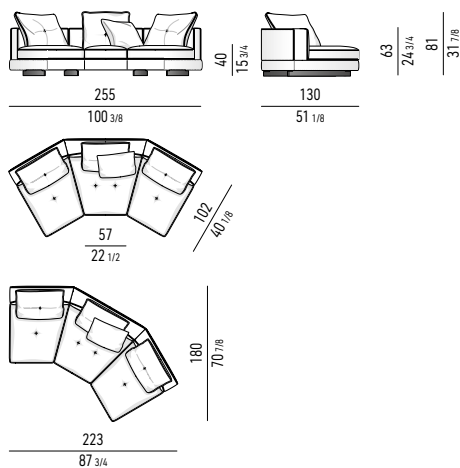

LOW DIVANO INCLINATO LOUNGE THEATRE SENZA BRACCIOLI CM 280X142
LOW LOUNGE THEATRE INCLINED SOFA WITHOUT ARMRESTS CM 280X142

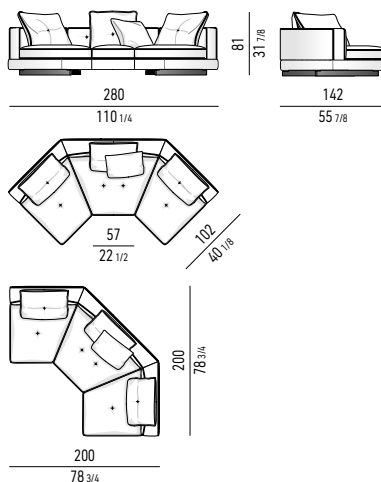

POUF | OTTOMANS

LOW POUF CM 59X79
LOW OTTOMAN CM 59X79

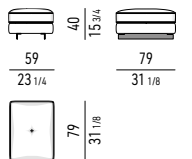

LOW POUF CM 70X79
LOW OTTOMAN CM 70X79

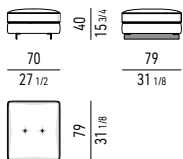

LOW POUF CM 79X79
LOW OTTOMAN CM 79X79

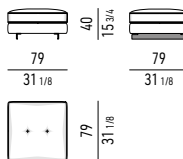

LOW POUF CM 59X102
LOW OTTOMAN CM 59X102

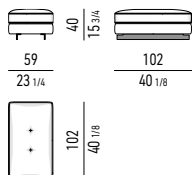

LOW POUF CM 70X102
LOW OTTOMAN CM 70X102

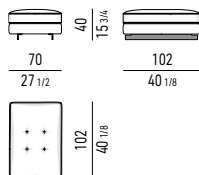

LOW POUF CM 79X102
LOW OTTOMAN CM 79X102

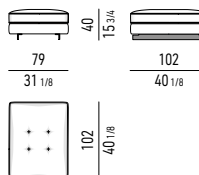

LOW POUF CM 93X102
LOW OTTOMAN CM 93X102

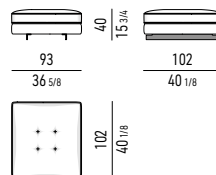

LOW POUF CM 102X102
LOW OTTOMAN CM 102X102

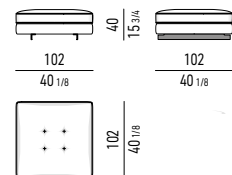

LOW POUF CM 70X48
LOW OTTOMAN CM 70X48

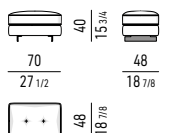

LOW POUF CM 79X48
LOW OTTOMAN CM 79X48

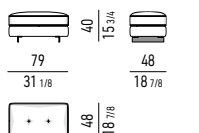

LOW POUF CM 102X48
LOW OTTOMAN CM 102X48

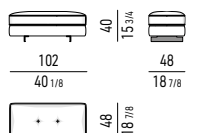

LOW POUF CM 140X48
LOW OTTOMAN CM 140X48

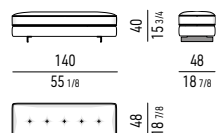

LOW POUF CM 158X48
LOW OTTOMAN CM 158X48

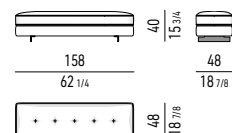

LOW POUF CM 140X140
LOW OTTOMAN CM 140X140

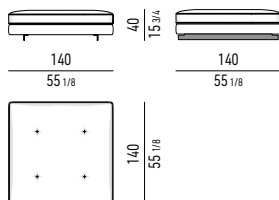

POUF INCLINATO | INCLINED OTTOMAN

LOW POUF INCLINATO CM 109X98
LOW INCLINED OTTOMAN CM 109X98

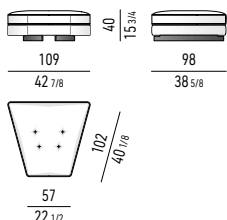

CUSCINI OPTIONAL | OPTIONAL CUSHIONS

CUSCINO SCHIENALE OPTIONAL CM 64X62
OPTIONAL BACKREST CUSHION CM 64X62

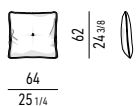

CUSCINO OPTIONAL CM 50X50
OPTIONAL CUSHION CM 50X50

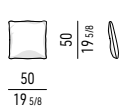

TAVOLINI | COFFEE TABLES

LOW TAVOLINO CM 70X102
LOW COFFEE TABLE CM 70X102

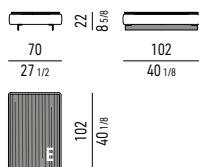

LOW TAVOLINO CM 79X102
LOW COFFEE TABLE CM 79X102

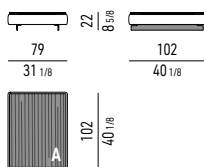

LOW TAVOLINO CM 102X102
LOW COFFEE TABLE CM 102X102

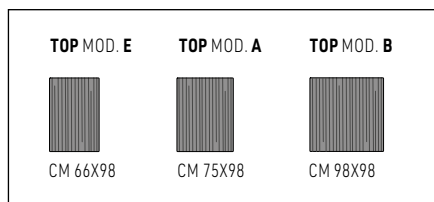
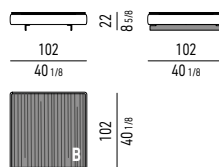

POGGIATESTA OPTIONAL | OPTIONAL HEADREST

POGGIATESTA OPTIONAL CM 64 H66
OPTIONAL HEADREST CM 64 H66

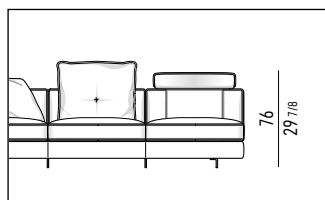
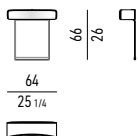

ABBINATO AD ELEMENTO CON MODULO SEDUTA CM 77
 PAIRED WITH ELEMENT WITH SEAT CUSHION CM 77

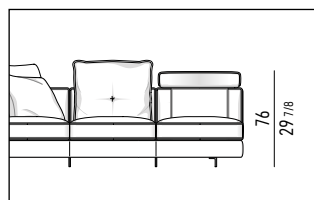

ABBINATO AD ELEMENTO CON MODULO SEDUTA CM 68
 PAIRED WITH ELEMENT WITH SEAT CUSHION CM 68